

LUCENTI

Dierre  
YOUR HOME, YOUR LIFE

# LU CENTI

**Dierre**  
YOUR HOME, YOUR LIFE



## Oltre le apparenze

Quello che vediamo è frutto della nostra capacità di osservare e di immaginare.

Lì dove finisce lo sguardo inizia la fantasia. E in quel preciso istante prendono vita le emozioni che intessono la nostra esistenza come sottili trame di luce, giochi di contrasti, pieni e vuoti in cui cercare un equilibrio.

In questo intravedere, vedere attraverso, vedere oltre, alcuni desideri si concretizzano, divenendo materia luminosa che definisce lo spazio e lascia all'immaginazione la libertà di creare nuove emozioni.

Con la linea di porte per interni LUCENTI, Dierre cattura l'essenza di queste emozioni attraverso la luce, per trasformarla in nuovi spazi da vivere.

## *Beyond appearances*

*Everything we see is the result of our ability to observe and to imagine.*

*Where the gaze ends, imagination begins. That's when emotions come to life the emotions that thread our existence like subtle light weaves, contrasts, fullness and emptiness where a balance is sought.*

*Some desires materialise in this glimpse, see through, see beyond, becoming luminous matter that defines space and leaves freedom to the imagination in creating new emotions.*

*With the LUCENTI line of interior doors, Dierre capture the very essence of these emotions through light, to transform it into new living spaces.*



# LUCENTI Porte in vetro

## LA MATERIA RACCONTA LA LUCE

Dierre cattura la trama narrativa della luce in questa nuova linea di porte a vetri, per raccontare lo spazio che prende vita.

**ANTA VETRO STRATIFICATO TEMPERATO** - Il vetro stratificato è composto da due lastre di vetro temperato assemblate su tutta la superficie mediante pellicola di PVB (Polivinilbutirrale), il vetro stratificato temperato offre una maggiore sicurezza perchè unisce la durezza del vetro temperato e l'elasticità della pellicola PVB. Questa tecnologia permette disegni / stampe / effetti di trasparenza all'interno della stratificazione.

**ANTA VETRO TEMPERATO** -La lastra in vetro subisce un trattamento termico di cottura che consiste nel riscaldamento del vetro fino alla temperatura di 700° per poi essere rapidamente raffreddato e riportato a temperatura ambientale. Con questo trattamento acquista le caratteristiche di resistenza cinque volte superiori agli shock termici e meccanici. In caso di rottura il vetro si rompe in migliaia di piccoli frammenti non taglienti.

**IMBALLO** - L'imballo per l'anta è eseguito in cassa in legno con protezioni. L'imballo per il telaio è costituito da involucro in cartone antiurto.

### Urban

INDUSTRIAL DECOR	8
INDUSTRIAL CHIC DECOR	24
DEKÒ	32
STRIPES	34
MIRROR	36

### Visual

NEUTRAL	48
FRAME	54
SETA	56
MARMO BLACK	58
MARMO WHITE	62
MARMO EMERALD	66

### Natural

SPRING	76
VALERY	78
DANDELION	82
LEAF	86

### Maniglie / Handles

93

### Sistemi di apertura / Opening systems

102

# INDICE



## LUCENTI Porte in vetro

### LA MATERIA RACCONTA LA LUCE

Dierre cattura la trama narrativa della luce in questa nuova linea di porte a vetri, per raccontare lo spazio che prende vita.

**ANTA VETRO STRATIFICATO TEMPERATO** - Il vetro stratificato è composto da due lastre di vetro temperato assemblate su tutta la superficie mediante pellicola di PVB (Polivinilbutirrale), il vetro stratificato temperato offre una maggiore sicurezza perchè unisce la durezza del vetro temperato e l'elasticità della pellicola PVB. Questa tecnologia permette disegni / stampe / effetti di trasparenza all'interno della stratificazione.

**ANTA VETRO TEMPERATO** -La lastra in vetro subisce un trattamento termico di cottura che consiste nel riscaldamento del vetro fino alla temperatura di 700° per poi essere rapidamente raffreddato e riportato a temperatura ambientale. Con questo trattamento acquista le caratteristiche di resistenza cinque volte superiori agli shock termici e meccanici. In caso di rottura il vetro si rompe in migliaia di piccoli frammenti non taglienti.

**IMBALLO** - L'imballo per l'anta è eseguito in cassa in legno con protezioni. L'imballo per il telaio è costituito da involucro in cartone antiurto.



URBAN



INDUSTRIAL DECOR HORIZONTAL - BRONZO / BRONZE

Autentico contemporaneo  
*Authentically contemporary*



## Urban

INDUSTRIAL DECOR	8
INDUSTRIAL CHIC DECOR	26
DEKÒ	34
STRIPES	36
MIRROR	38
CORNICE PERIMETRALE	44







**INDUSTRIAL DECOR**  
 vetro trasparente extrachiaro  
*extra-clear transparent glass*



**INDUSTRIAL DECOR**  
 vetro trasparente grigio  
*grey transparent glass*



**INDUSTRIAL DECOR**  
 vetro trasparente bronzo  
*bronze transparent glass*



## Urban INDUSTRIAL DECOR

Il movimento delle linee orizzontali crea nuovo spazio e arreda, lasciando agli ambienti la loro intimità. Porta a vetro e listelli orizzontali decorativi, per fare luce e ombra allo stesso tempo.

*Horizontal line movement creates new space and furnishes leaving the rooms their own intimacy. Glass door and horizontal decorative slats, to provide light and shade at the same time.*

Descrizione: vetro trasparente extrachiaro con listelli orizzontali decorativi predisposto per perimetro in alluminio spessore 4+4 mm / *Description: extra-clear transparent glass with decorative horizontal strips prepared for 4+4 mm thick aluminium perimeter*

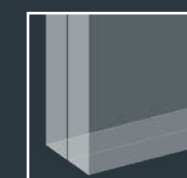

### Vetro

Vetro trasparente extrachiaro  
*extra-clear transparent glass*

Vetro trasparente grigio  
*grey transparent glass*

Vetro trasparente bronzo  
*bronze transparent glass*

### Stampato digitale

Nero / *Black*

Bianco / *White*

Bronzo chiaro / *Light bronze*

Grigio / *Grey*





**INDUSTRIAL DECOR**  
 vetro trasparente extrachiaro  
*extra-clear transparent glass*



**INDUSTRIAL DECOR**  
 vetro trasparente grigio  
*grey transparent glass*



**INDUSTRIAL DECOR**  
 vetro trasparente bronzo  
*bronze transparent glass*



## Urban INDUSTRIAL DECOR

Il movimento delle linee orizzontali crea nuovo spazio e arreda, lasciando agli ambienti la loro intimità. Porta a vetro e listelli orizzontali decorativi, per fare luce e ombra allo stesso tempo.

*Horizontal line movement creates new space and furnishes leaving the rooms their own intimacy. Glass door and horizontal decorative slats, to provide light and shade at the same time.*

Descrizione: vetro trasparente con listelli orizzontali decorativi predisposto per perimetro in alluminio spessore 4+4 mm / *Description: extra-clear transparent glass with decorative horizontal strips prepared for 4+4 mm thick aluminium perimeter*

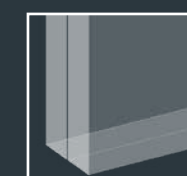

### Vetro

Vetro trasparente extrachiaro  
*extra-clear transparent glass*

Vetro trasparente grigio  
*grey transparent glass*

Vetro trasparente bronzo  
*bronze transparent glass*

### Stampato digitale

Nero / *Black*

Bianco / *White*

Bronzo chiaro / *Light bronze*

Grigio / *Grey*





**INDUSTRIAL DECOR**  
 vetro trasparente extrachiaro  
*extra-clear transparent glass*



**INDUSTRIAL DECOR**  
 vetro trasparente grigio  
*grey transparent glass*



**INDUSTRIAL DECOR**  
 vetro trasparente bronzo  
*bronze transparent glass*

## Urban INDUSTRIAL DECOR

Il movimento delle linee orizzontali crea nuovo spazio e arreda, lasciando agli ambienti la loro intimità. Porta a vetro e listelli orizzontali decorativi, per fare luce e ombra allo stesso tempo.

*Horizontal line movement creates new space and furnishes leaving the rooms their own intimacy. Glass door and horizontal decorative slats, to provide light and shade at the same time.*

Descrizione: vetro trasparente con listelli orizzontali decorativi predisposto per perimetro in alluminio spessore 4+4 mm / *Description: extra-clear transparent glass with decorative horizontal strips prepared for 4+4 mm thick aluminium perimeter*

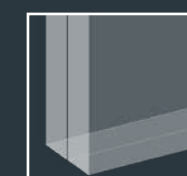

### Vetro

Vetro trasparente extrachiaro  
*extra-clear transparent glass*

Vetro trasparente grigio  
*grey transparent glass*

Vetro trasparente bronzo  
*bronze transparent glass*

### Stampato digitale

Nero / *Black*

Bianco / *White*

Bronzo chiaro / *Light bronze*

Grigio / *Grey*





**INDUSTRIAL DECOR**  
 vetro trasparente extrachiaro  
*extra-clear transparent glass*



**INDUSTRIAL DECOR**  
 vetro trasparente grigio  
*grey transparent glass*



**INDUSTRIAL DECOR**  
 vetro trasparente bronzo  
*bronze transparent glass*



## Urban INDUSTRIAL DECOR

Il movimento delle linee orizzontali crea nuovo spazio e arreda, lasciando agli ambienti la loro intimità. Porta a vetro e listelli orizzontali decorativi, per fare luce e ombra allo stesso tempo.

*Horizontal line movement creates new space and furnishes leaving the rooms their own intimacy. Glass door and horizontal decorative slats, to provide light and shade at the same time.*

Descrizione: vetro trasparente con listelli orizzontali decorativi predisposto per perimetro in alluminio spessore 4+4 mm / *Description: extra-clear transparent glass with decorative horizontal strips prepared for 4+4 mm thick aluminium perimeter*

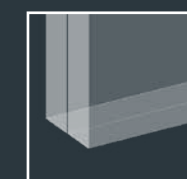

### Vetro

Vetro trasparente extrachiaro  
*extra-clear transparent glass*

Vetro trasparente grigio  
*grey transparent glass*

Vetro trasparente bronzo  
*bronze transparent glass*

### Stampato digitale

Nero / *Black*

Bianco / *White*

Bronzo chiaro / *Light bronze*

Grigio / *Grey*





**INDUSTRIAL DECOR**  
 vetro trasparente extrachiaro  
*extra-clear transparent glass*



**INDUSTRIAL DECOR**  
 vetro trasparente grigio  
*grey transparent glass*



**INDUSTRIAL DECOR**  
 vetro trasparente bronzo  
*bronze transparent glass*



## Urban INDUSTRIAL DECOR

Linee verticali, per un gioco di vedo-non-vedo che dà slancio a ogni ambiente.

Porta a vetro e listelli verticali con un effetto plissé molto contemporaneo.

*Vertical lines, for a see-through effect that provides an added boost to any environment.*

*Glass door and vertical slats with a very contemporary pleated effect.*

Descrizione: vetro trasparente con listelli verticali decorativi predisposto per perimetro in alluminio spessore 4+4 mm / *Description: clear glass with vertical decorative strips prepared for aluminium perimeter thickness 4+4 mm*

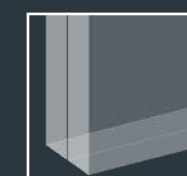

### Vetro

Vetro trasparente extrachiaro  
*extra-clear transparent glass*

Vetro trasparente grigio  
*grey transparent glass*

Vetro trasparente bronzo  
*bronze transparent glass*

### Stampato digitale

Nero / *Black*

Bianco / *White*

Bronzo chiaro / *Light bronze*

Grigio / *Grey*





**INDUSTRIAL DECOR**  
 vetro trasparente extrachiaro  
*extra-clear transparent glass*



**INDUSTRIAL DECOR**  
 vetro trasparente grigio  
*grey transparent glass*



**INDUSTRIAL DECOR**  
 vetro trasparente bronzo  
*bronze transparent glass*



## Urban INDUSTRIAL DECOR

Linee verticali, per un gioco di vedo-non-vedo che dà slancio a ogni ambiente.

Porta a vetro e listelli verticali con un effetto plissé molto contemporaneo.

*Vertical lines, for a see-through effect that provides an added boost to any environment.*

*Glass door and vertical slats with a very contemporary pleated effect.*

Descrizione: vetro trasparente con listelli verticali decorativi predisposto per perimetro in alluminio spessore 4+4 mm / *Description: clear glass with vertical decorative strips prepared for aluminium perimeter thickness 4+4 mm*

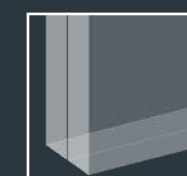

### Vetro

Vetro trasparente extrachiaro  
*extra-clear transparent glass*

Vetro trasparente grigio  
*grey transparent glass*

Vetro trasparente bronzo  
*bronze transparent glass*

### Stampato digitale

Nero / *Black*

Bianco / *White*

Bronzo chiaro / *Light bronze*

Grigio / *Grey*





**INDUSTRIAL DECOR**  
 vetro trasparente extrachiaro  
*extra-clear transparent glass*



**INDUSTRIAL DECOR**  
 vetro trasparente grigio  
*grey transparent glass*



**INDUSTRIAL DECOR**  
 vetro trasparente bronzo  
*bronze transparent glass*

## Urban INDUSTRIAL DECOR

Linee verticali, per un gioco di vedo-non-vedo che dà slancio a ogni ambiente.  
 Porta a vetro e listelli verticali con un effetto plissé molto contemporaneo.

*Vertical lines, for a see-through effect that provides an added boost to any environment.  
 Glass door and vertical slats with a very contemporary pleated effect.*

Descrizione: vetro trasparente con listelli verticali decorativi predisposto per perimetro in alluminio spessore 4+4 mm / *Description: clear glass with vertical decorative strips prepared for aluminium perimeter thickness 4+4 mm*

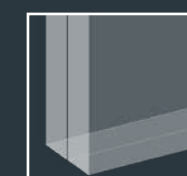

### Vetro

Vetro trasparente extrachiaro  
*extra-clear transparent glass*

Vetro trasparente grigio  
*grey transparent glass*

Vetro trasparente bronzo  
*bronze transparent glass*

### Stampato digitale

Nero / *Black*

Bianco / *White*

Bronzo chiaro / *Light bronze*

Grigio / *Grey*





**INDUSTRIAL DECOR**  
 vetro trasparente extrachiaro  
*extra-clear transparent glass*



**INDUSTRIAL DECOR**  
 vetro trasparente grigio  
*grey transparent glass*



**INDUSTRIAL DECOR**  
 vetro trasparente bronzo  
*bronze transparent glass*



## Urban INDUSTRIAL DECOR

Linee verticali, per un gioco di vedo-non-vedo che dà slancio a ogni ambiente.

Porta a vetro e listelli verticali con un effetto plissé molto contemporaneo.

*Vertical lines, for a see-through effect that provides an added boost to any environment.*

*Glass door and vertical slats with a very contemporary pleated effect.*

Descrizione: vetro trasparente con listelli verticali decorativi predisposto per perimetro in alluminio spessore 4+4 mm / *Description: clear glass with vertical decorative strips prepared for aluminium perimeter thickness 4+4 mm*

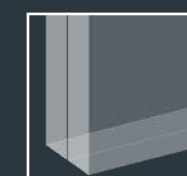

### Vetro

Vetro trasparente extrachiaro  
*extra-clear transparent glass*

Vetro trasparente grigio  
*grey transparent glass*

Vetro trasparente bronzo  
*bronze transparent glass*

### Stampato digitale

Nero / *Black*

Bianco / *White*

Bronzo chiaro / *Light bronze*

**Grigio / *Grey***





**INDUSTRIAL CHIC DECOR**  
 vetro trasparente extrachiaro  
*extra-clear transparent glass*



**INDUSTRIAL CHIC DECOR**  
 vetro trasparente grigio  
*grey transparent glass*



**INDUSTRIAL CHIC DECOR**  
 vetro trasparente bronzo  
*bronze transparent glass*



## Urban INDUSTRIAL CHIC DECOR

Geometrie e proporzioni definiscono lo spazio, regalando armonia e personalità.  
 Porta a vetro caratterizzata da un raffinato disegno a quadri.

*Shapes and proportions define the space, bringing harmony and personality. Glass door featuring a refined checked pattern.*

Descrizione: vetro trasparente con listelli inglesina decorativi predisposto per perimetro in alluminio spessore 4+4 mm / *Descrizione: vetro trasparente con listelli stampati che disegnano riquadri predisposto per perimetro*

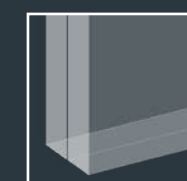

### Vetro

Vetro trasparente extrachiaro  
*extra-clear transparent glass*

Vetro trasparente grigio  
*grey transparent glass*

Vetro trasparente bronzo  
*bronze transparent glass*

### Stampato digitale

Nero / *Black*

Bianco / *White*

Bronzo chiaro / *Light bronze*

Grigio / *Grey*





**INDUSTRIAL CHIC DECOR**  
 vetro trasparente extrachiaro  
*extra-clear transparent glass*



**INDUSTRIAL CHIC DECOR**  
 vetro trasparente grigio  
*grey transparent glass*



**INDUSTRIAL CHIC DECOR**  
 vetro trasparente bronzo  
*bronze transparent glass*



## Urban INDUSTRIAL CHIC DECOR

Geometrie e proporzioni definiscono lo spazio, regalando armonia e personalità.  
 Porta a vetro caratterizzata da un raffinato disegno a quadri.

*Geometrie e proporzioni definiscono lo spazio, regalando armonia e personalità.  
 Porta a vetro caratterizzata da un raffinato disegno a quadri.*

Descrizione: vetro trasparente con listelli inglesina decorativi predisposto per perimetro in alluminio spessore 4+4 mm / *Descrizione: vetro trasparente con listelli stampati che disegnano riquadri predisposto per perimetro*

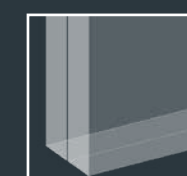

### Vetro

Vetro trasparente extrachiaro  
*extra-clear transparent glass*

Vetro trasparente grigio  
*grey transparent glass*

Vetro trasparente bronzo  
*bronze transparent glass*

### Stampato digitale

Nero / *Black*

Bianco / *White*

Bronzo chiaro / *Light bronze*

Grigio / *Grey*





**INDUSTRIAL CHIC DECOR**  
 vetro trasparente extrachiaro  
*extra-clear transparent glass*



**INDUSTRIAL CHIC DECOR**  
 vetro trasparente grigio  
*grey transparent glass*



**INDUSTRIAL CHIC DECOR**  
 vetro trasparente bronzo  
*bronze transparent glass*



## Urban INDUSTRIAL CHIC DECOR

Geometrie e proporzioni definiscono lo spazio, regalando armonia e personalità.  
 Porta a vetro caratterizzata da un raffinato disegno a quadri.

*Geometrie e proporzioni definiscono lo spazio, regalando armonia e personalità.  
 Porta a vetro caratterizzata da un raffinato disegno a quadri.*

Descrizione: vetro trasparente con listelli inglesina decorativi predisposto per perimetro in alluminio spessore 4+4 mm / *Descrizione: vetro trasparente con listelli stampati che disegnano riquadri predisposto per perimetro*

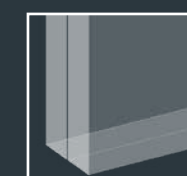

### Vetro

Vetro trasparente extrachiaro  
*extra-clear transparent glass*

Vetro trasparente grigio  
*grey transparent glass*

Vetro trasparente bronzo  
*bronze transparent glass*

### Stampato digitale

Nero / *Black*

Bianco / *White*

Bronzo chiaro / *Light bronze*

Grigio / *Grey*





**INDUSTRIAL CHIC DECOR**  
 vetro trasparente extrachiaro  
*extra-clear transparent glass*



**INDUSTRIAL CHIC DECOR**  
 vetro trasparente grigio  
*grey transparent glass*



**INDUSTRIAL CHIC DECOR**  
 vetro trasparente bronzo  
*bronze transparent glass*



## Urban INDUSTRIAL CHIC DECOR

Geometrie e proporzioni definiscono lo spazio, regalando armonia e personalità.  
 Porta a vetro caratterizzata da un raffinato disegno a quadri.

*Geometrie e proporzioni definiscono lo spazio, regalando armonia e personalità.  
 Porta a vetro caratterizzata da un raffinato disegno a quadri.*

Descrizione: vetro trasparente con listelli inglesina decorativi predisposto per perimetro in alluminio spessore 4+4 mm / *Descrizione: vetro trasparente con listelli stampati che disegnano riquadri predisposto per perimetro*

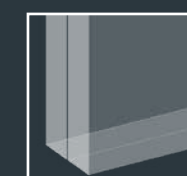

### Vetro

Vetro trasparente extrachiaro  
*extra-clear transparent glass*

Vetro trasparente grigio  
*grey transparent glass*

Vetro trasparente bronzo  
*bronze transparent glass*

### Stampato digitale

Nero / *Black*

Bianco / *White*

Bronzo chiaro / *Light bronze*

Grigio / *Grey*



## Urban DEKÒ

Un pattern ritmico a linee morbide decora con semplicità il vetro dalle tinte neutre. Porta a vetro decorata, sofisticata in ogni ambiente.

*Soft-line rhythmic patterning simply decorates the glass in neutral colours. Decorated glass door, refined in any environment.*

Descrizione: vetro trasparente stampato digitale con disegno Dekò spessore 10 mm / *Description: digitally printed clear glass with Dekò design 10 mm thick*

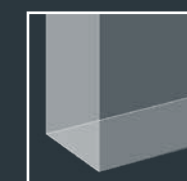

### Vetro

Vetro trasparente bronzo  
*bronze transparent glass*

Vetro trasparente grigio  
*grey transparent glass*



DEKÒ  
vetro trasparente bronzo  
*bronze transparent glass*



DEKÒ  
vetro trasparente grigio  
*grey transparent glass*



## Urban STRIPES

Nella nervatura verticale la luce si insinua, per diffondersi in un gioco di forme e volumi. Porta a vetro striato che separa senza rinunciare alla luminosità.

*Light creeps into the vertical ribbing, to diffuse in an interplay of shapes and volumes.*

*Striped glass door that separates without compromising brightness.*

**STRIPES**  
vetro satinato extrachiaro  
*extra-clear satin glass*



Descrizione: vetro satinato extrachiaro modello stripes predisposto per perimetro in alluminio spessore 10 mm / *Description: extra-clear satin glass stripes model prepared for aluminium perimeter 10 mm thick*

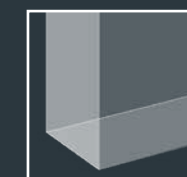

### Vetro

Vetro satinato extrachiaro  
*Extra-clear satin glass*

Perimetro intelaiato colori pag 44  
*Framed perimeter colours page 44*



## Urban MIRROR

Amplifica lo spazio, attira la luce, riflette la bellezza.

Porta con anta a specchio dalle linee leggere. Ideale per camere da letto con cabine armadio o per arredare spazi piccoli.

*Amplifies space, attracts light, reflects beauty.*

*Mirror door with light lines.*

*Ideal for bedrooms with walk-in wardrobes or for furnishing small spaces.*



MIRROR  
specchio classic  
*classic mirror*

Descrizione: specchio classic predisposto per perimetro in alluminio spessore 4+4 mm / *Description: classic mirror prepared for aluminium perimeter 4+4 mm thick*

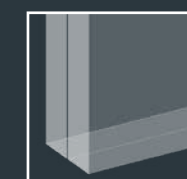

### Vetro

Specchio classic  
*Classic mirror*

Perimetro intelaiato colori pag 44  
*Framed perimeter colours page 44*



## Urban MIRROR

Amplifica lo spazio, attira la luce, riflette la bellezza.

Porta con anta a specchio dalle linee leggere. Ideale per camere da letto con cabine armadio o per arredare spazi piccoli.

*Amplifies space, attracts light, reflects beauty.*

*Mirror door with light lines.*

*Ideal for bedrooms with walk-in wardrobes or for furnishing small spaces.*



MIRROR  
specchio fumè  
smoked mirror

Descrizione: specchio fumé predisposto per perimetro in alluminio spessore 4+4 mm / Description: smoked mirror prepared for aluminium perimeter 4+4 mm thick

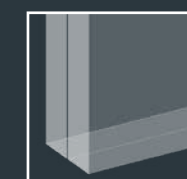

### Vetro

Specchio fumé  
Smoked mirror

Perimetro intelaiato colori pag 44  
Framed perimeter colours page 44



# Urban

## INDUSTRIAL DECOR ORIZZONTALE



Nero / Black



Bianco / White

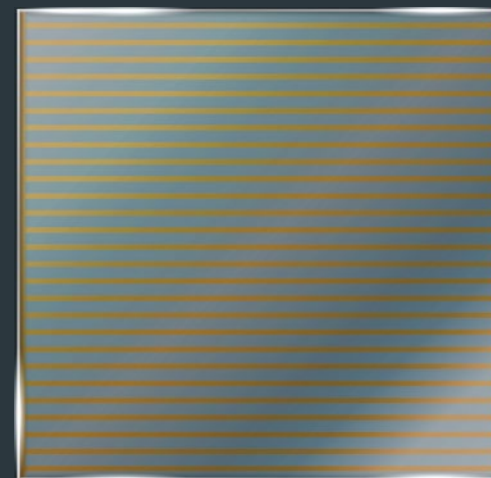

Bronzo / Bronze

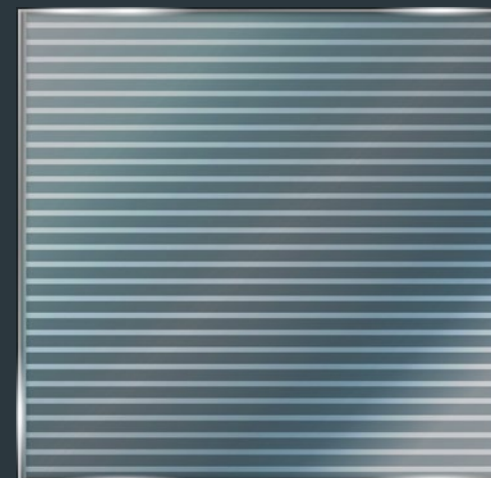

Grigio / Grey

## DEKO'

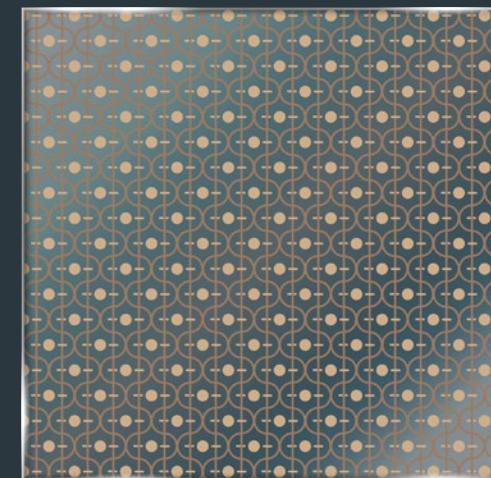

## STRIPES



## INDUSTRIAL DECOR VERTICALE



Nero / Black



Bianco / White

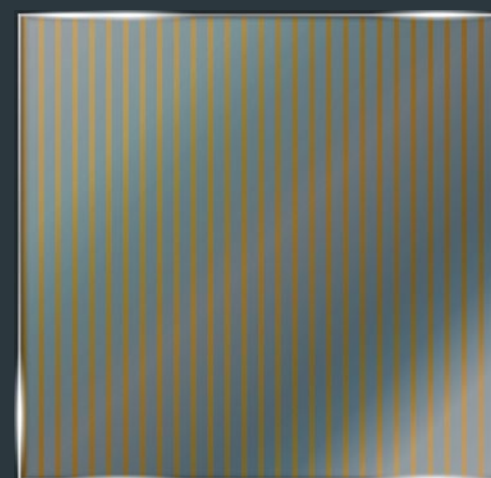

Bronzo / Bronze



Grigio / Grey

## MIRROR



Specchio classic

## MIRROR



Specchio fumé

## INDUSTRIAL CHIC DECOR



Nero / Black

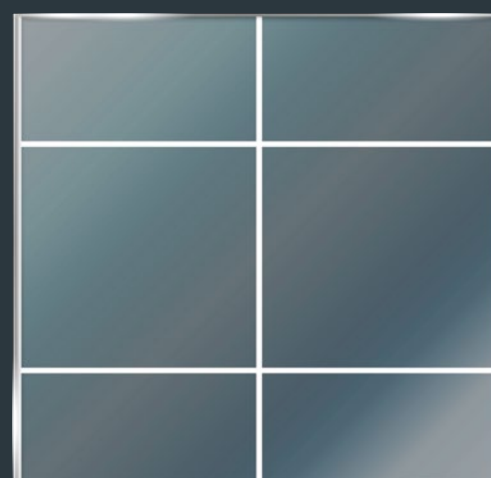

Bianco / White

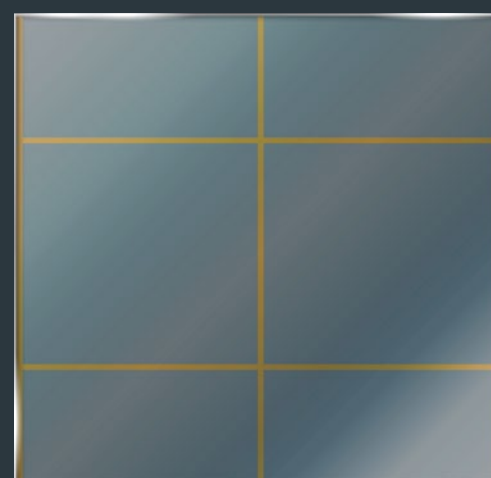

Bronzo / Bronze



Grigio / Grey

VETTRI URBAN



# CORNICE PERIMETRALE



## CORNICE PERIMETRALE

Modello Industrial e Mirror predisposti per perimetro in alluminio.  
Spessore 4 + 4 mm

Modello Stripes predisposto per perimetro in alluminio.  
Spessore 10 mm

## PERIMETER CORNICE

*Industrial and Mirror models prepared for aluminium perimeter.  
Thickness 4 + 4 mm*

*Stripes model prepared for aluminium perimeter.  
Thickness 10 mm*

## Flinitura

Grigio  
Grey  
Bronzo chiaro  
Light bronze  
Bianco opaco  
Matt white  
Nero opaco  
Matte black

## Modelli

Industrial decor horizontal  
Industrial decor vertical  
Industrial chic decor  
Mirror  
Stripes



VISUAL



MARMO / MARBLE - BLACK ORIZZONTALE / HORIZONTAL BLACK

Dettagli di stile  
*Stylish details*



## Visual

NEUTRAL	50
FRAME	56
SETA	58
MARMO BLACK	60
MARMO WHITE	64
MARMO EMERALD	68







**NEUTRAL**  
**vetro satinato chiaro**  
*clear satin glass*



## Visual NEUTRAL

La luce nella sua forma più pura.  
 Essenziale, elegante, rivelatrice.  
 Porta trasparente che separa  
 gli ambienti conservando continuità.  
 Arreda con discrezione,  
 si lascia ammirare quando serve.

*Light in its purest form.  
 Essential, elegant, revealing.  
 See-through door separating  
 environments while preserving continuity.  
 Furnishes discretely, it can be admired  
 when needed.*

Descrizione: vetro satinato chiaro spessore 8 mm / Description: clear satin glass thickness 8 mm

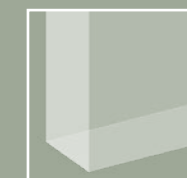

### Vetro

Vetro satinato chiaro  
*Clear satin glass*



## Visual NEUTRAL

La luce nella sua forma più pura.  
Essenziale, elegante, rivelatrice.  
Porta trasparente che separa  
gli ambienti conservando continuità.  
Arreda con discrezione,  
si lascia ammirare quando serve.

*Light in its purest form.  
Essential, elegant, revealing.  
See-through door separating  
environments while preserving continuity.  
Furnishes discretely, it can be admired  
when needed.*

Descrizione: vetro trasparente extrachiaro  
spessore 8 mm / *Description: extra-clear  
transparent glass thickness 8 mm*

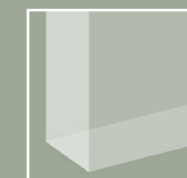

### Vetro

Vetro trasparente extrachiaro  
*Extra-clear transparent glass*



**NEUTRAL**  
vetro trasparente extrachiaro  
*extra-clear transparent glass*



## Visual NEUTRAL

La luce nella sua forma più pura.  
Essenziale, elegante, rivelatrice.  
Porta trasparente che separa  
gli ambienti conservando continuità.  
Arreda con discrezione,  
si lascia ammirare quando serve.

*Light in its purest form.  
Essential, elegant, revealing.  
See-through door separating  
environments while preserving continuity.  
Furnishes discretely, it can be admired  
when needed.*

Descrizione: vetro trasparente grigio spessore  
8 mm / Description: grey transparent glass  
thickness 8 mm



### Vetro

Vetro trasparente grigio  
Grey transparent glass



NEUTRAL  
vetro trasparente grigio  
grey transparent glass





## Visual FRAME

La forma dell'eleganza è una geometria di trasparenze che esprime la personalità di ogni ambiente.  
Porta a vetro con decorazioni geometriche nei toni nero, grigio e bianco.

*An elegant shape is a geometry of transparencies that expresses the personality of each environment.  
Glass door with geometric decorations in black, grey and white.*

Descrizione: vetro stampato digitale spessore 5 + 5 mm - 10 mm / Description: digitally printed glass thickness 5 + 5 mm - 10 mm

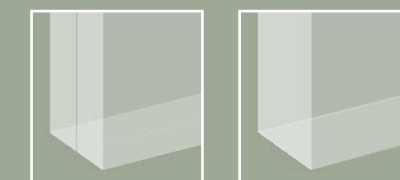

### Vetro

Vetro trasparente extrachiaro  
Extra-clear transparent glass

Vetro satinato chiaro  
Clear satin glass

### Stampato digitale

Decoro geometrico / Geometric decoration



FRAME  
vetro trasparente extrachiaro  
extra-clear transparent glass

FRAME  
vetro satinato chiaro  
clear satin glass

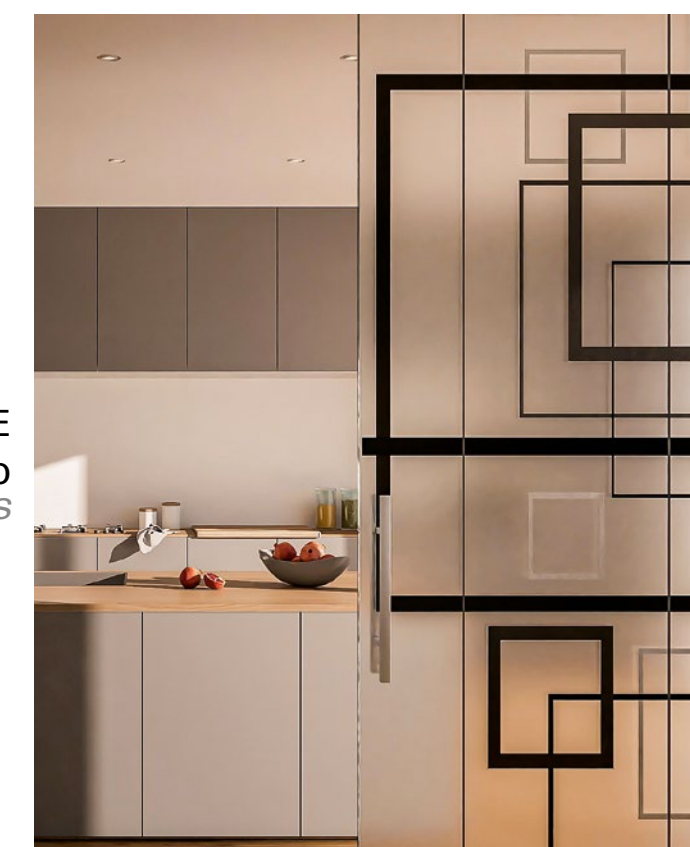



## Visual SETA

Immergersi nella bellezza di onde di luce che ricordano l'armonia della natura.

Porta a vetro con sottili decorazioni stampate in digitale.

*Dipping into the beauty of waves of light reminiscent of the harmony of nature.*

*Glass door with digitally printed fine decors.*

Descrizione: vetro satinato chiaro stampato digitale con disegno seta spessore 10 mm /  
Description: clear digitally printed satin glass with silk design thickness 10 mm

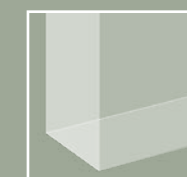

### Vetro

Vetro satinato chiaro  
Clear satin glass

### Stampato digitale

Grey / Grey  
Ocra / Ocher



SETA Grey  
vetro satinato chiaro  
clear satin glass



SETA Ocra  
vetro satinato chiaro  
clear satin glass

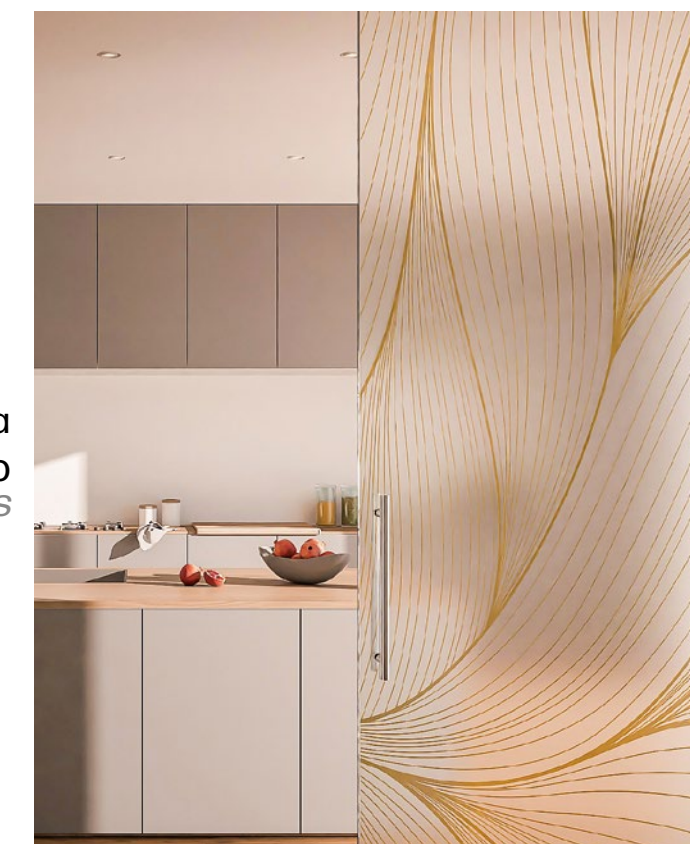





**MARMO**  
 vetro trasparente extrachiaro  
*extra-clear transparent glass*

## Visual **MARMO Black**

Il prestigio della materia, la forza dei contrasti tra la trasparenza del vetro e il fascino del marmo. Porta a vetro con inserto in marmo. Il classico interpretato in chiave contemporanea.

*The prestige of substance, the strength of contrasts between the transparency of glass and the charm of marble. Glass door with marble insert. Classic interpreted in a contemporary contemporary.*

Descrizione: vetro trasparente extrachiaro stampato digitale con disegno verticale marmo black spessore 5+5 mm / *Description: extra-clear transparent glass digitally printed with vertical black marble pattern 5+5 mm thick*

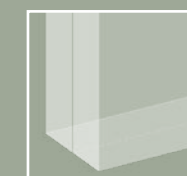

### **Vetro**

Vetro trasparente extrachiaro  
*Extra-clear transparent glass*

### **Stampato digitale**

**Verticale marmo black / Vertical black marble**  
 Orizzontale marmo black / *Horizontal black marble*





**MARMO**  
 vetro trasparente extrachiaro  
 extra-clear transparent glass



## Visual MARMO Black

Il prestigio della materia, la forza dei contrasti tra la trasparenza del vetro e il fascino del marmo. Porta a vetro con inserto in marmo. Il classico interpretato in chiave contemporanea.

*The prestige of substance, the strength of contrasts between the transparency of glass and the charm of marble. Glass door with marble insert. Classic interpreted in a contemporary contemporary.*

Descrizione: vetro trasparente extrachiaro stampato digitale con disegno orizzontale marmo black spessore 5+5 mm / *Description: extra-clear transparent glass digitally printed with horizontal black marble pattern 5+5 mm thick*

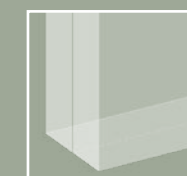

### Vetro

Vetro trasparente extrachiaro  
 Extra-clear transparent glass

### Stampato digitale

Verticale marmo black / *Vertical black marble*  
 Orizzontale marmo black / *Horizontal black marble*





**MARMO**  
 vetro trasparente extrachiaro  
 extra-clear transparent glass

## Visual MARMO White

Il prestigio della materia, la forza dei contrasti tra la trasparenza del vetro e il fascino del marmo. Porta a vetro con inserto in marmo. Il classico interpretato in chiave contemporanea.

*The prestige of substance, the strength of contrasts between the transparency of glass and the charm of marble. Glass door with marble insert. Classic interpreted in a contemporary contemporary.*

Descrizione: vetro trasparente extrachiaro stampato digitale con disegno verticale marmo white spessore 5+5 mm / *Description: extra-clear transparent glass digitally printed with vertical white marble pattern 5+5 mm thick*

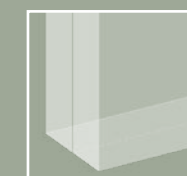

### Vetro

Vetro trasparente extrachiaro  
 Extra-clear transparent glass

### Stampato digitale

Verticale marmo white / *Vertical white marble*  
 Orizzontale marmo white / *Horizontal white marble*



## Visual MARMO White

Il prestigio della materia, la forza dei contrasti tra la trasparenza del vetro e il fascino del marmo. Porta a vetro con inserto in marmo. Il classico interpretato in chiave contemporanea.

*The prestige of substance, the strength of contrasts between the transparency of glass and the charm of marble. Glass door with marble insert. Classic interpreted in a contemporary contemporary.*

Descrizione: vetro trasparente extrachiaro stampato digitale con disegno orizzontale marmo white spessore 5+5 mm / *Description: extra-clear transparent glass digitally printed with horizontal white marble pattern 5+5 mm thick*

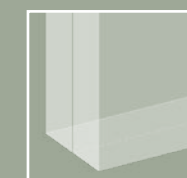

### Vetro

Vetro trasparente extrachiaro  
*Extra-clear transparent glass*

### Stampato digitale

Verticale marmo white / *Vertical white marble*  
Orizzontale marmo white / *Horizontal white marble*



**MARMO**  
vetro trasparente extrachiaro  
*extra-clear transparent glass*







**MARMO**  
 vetro trasparente extrachiaro  
 extra-clear transparent glass

## Visual MARMO Emerald

Il prestigio della materia, la forza dei contrasti tra la trasparenza del vetro e il fascino del marmo. Porta a vetro con inserto in marmo. Il classico interpretato in chiave contemporanea.

*The prestige of substance, the strength of contrasts between the transparency of glass and the charm of marble. Glass door with marble insert. Classic interpreted in a contemporary contemporary.*

Descrizione: vetro trasparente extrachiaro stampato digitale con disegno verticale marmo emerald spessore 5+5 mm / *Description: extra-clear transparent glass digitally printed with vertical emerald marble pattern 5+5 mm thick*

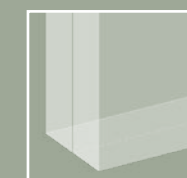

### Vetro

Vetro trasparente extrachiaro  
 Extra-clear transparent glass

### Stampato digitale

Verticale marmo emerald / *Vertical emerald marble*  
 Orizzontale marmo white / *Horizontal white marble*





**MARMO**  
 vetro trasparente extrachiaro  
*extra-clear transparent glass*



## Visual **MARMO Emerald**

Il prestigio della materia, la forza dei contrasti tra la trasparenza del vetro e il fascino del marmo. Porta a vetro con inserto in marmo. Il classico interpretato in chiave contemporanea.

*The prestige of substance, the strength of contrasts between the transparency of glass and the charm of marble. Glass door with marble insert. Classic interpreted in a contemporary contemporary.*

Descrizione: vetro trasparente extrachiaro stampato digitale con disegno orizzontale marmo emerald spessore 5+5 mm / *Description: extra-clear transparent glass digitally printed with horizontal emerald marble pattern 5+5 mm thick*

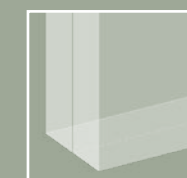

### **Vetro**

Vetro trasparente extrachiaro  
*Extra-clear transparent glass*

### **Stampato digitale**

Verticale marmo emerald / *Vertical emerald marble*  
 Orizzontale marmo white / *Horizontal white marble*



## Visual

## NEUTRAL



Vetro satinato chiaro /  
Clear satin glass



Vetro trasparente extrachiaro /  
Extra-clear transparent glass

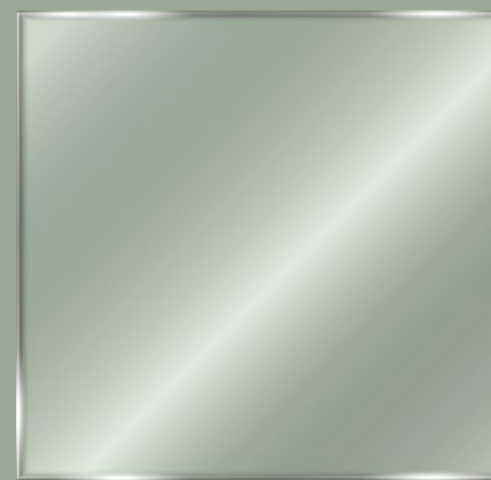

Vetro trasparente grigio /  
Transparent gray glass

## MARMO / MARBLE



Black verticale /  
vertical Black



Black orizzontale /  
horizontal Black

## FRAME



Decoro geometrico /  
Geometric pattern



Ocra / Ocher

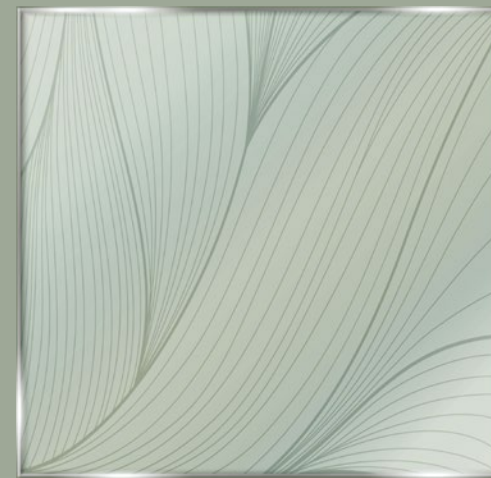

Grey

## MARMO / MARBLE



White verticale /  
White vertical



White orizzontale /  
White horizontal

## MARMO / MARBLE



Emerald verticale /  
Vertical Emerald



Emerald orizzontale /  
Horizontal Emerald



# NATURAL



SPRING - DECORO NATURA / NATURE DECORATION

Spazio alla natura  
*Open to nature*



**Natural**

SPRING	78
VALERY	80
DANDELION	84
LEAF	88







**SPRING**  
**vetro trasparente extrachiaro**  
*extra-clear transparent glass*



**SPRING**  
**vetro satinato chiaro**  
*clear satin glass*

## Visual SPRING

L'essenza della primavera entra in ogni ambiente e porta freschezza e leggerezza con decori delicati. Porta a vetro con decorazione a colori, per una casa dai toni caldi e naturali e per chi cerca la tranquillità della natura.

*Spring scents enter into every room bringing freshness and lightness with delicate decors.*

*Glass door with coloured pattern, for a home with warm, natural tones and for those seeking the peacefulness of nature.*

Descrizione: vetro stampato digitale con disegno spring spessore 5+5 mm - 10 mm / *Description: digitally printed glass with spring pattern thickness 5+5 mm - 10 mm*



### Vetro

Vetro trasparente extrachiaro  
*Extra-clear transparent glass*

Vetro satinato chiaro  
*Clear satin glass*

### Stampato digitale Digitally printed

Decoro natura / *Nature pattern*



## Visual VALERY Ocra

Tra luce e ombra prende vita l'eleganza, delineata dalla silhouette di grandi ninfee. Porta a vetro con decorazione digitale, dai toni caldi dell'ocra o del grigio chiaro.

*Between light and shadow, elegance comes to life, outlined by the contours of large water lilies. Glass door with digital decoration, in warm tones of ochre or light grey.*

VALERY  
vetro satinato grigio  
*grey satin glass*

Descrizione: vetro stampato digitale con disegno Valery spessore 10 mm / *Description: digitally printed glass with Valery pattern thickness 10 mm*

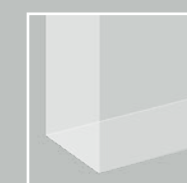

### Vetro

Satinato grigio  
*Satin grey*

### Stampato digitale *Digitally printed*

Ocra / Ocher

Grigio chiaro / *Light grey*





## Visual VALERY Grigio chiaro

Tra luce e ombra prende vita l'eleganza, delineata dalla silhouette di grandi ninfee. Porta a vetro con decorazione digitale, dai toni caldi dell'ocra o del grigio chiaro.

*Between light and shadow, elegance comes to life, outlined by the contours of large water lilies. Glass door with digital decoration, in warm tones of ochre or light grey.*

Descrizione: vetro stampato digitale con disegno Valery spessore 10 mm / *Description: digitally printed glass with Valery pattern thickness 10 mm*

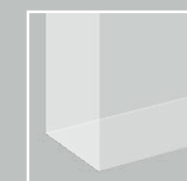

### Vetro

Satinato grigio  
Satin grey

### Stampato digitale Digitally printed

Ocra / Ocher  
Grigio chiaro / Light grey



VALERY  
vetro satinato grigio  
grey satin glass





**DANDELION**  
**vetro trasparente extrachiaro**  
*extra-clear transparent glass*



**DANDELION**  
**vetro satinato chiaro**  
*clear satin glass*

## Visual **DANDELION White**

Simbolo di leggerezza e delicatezza per eccellenza, il soffione porta il suo incanto e la sua finezza in ogni ambiente. Porta a vetro con decorazione digitale in bianco o nero.

*Lightness and delicacy par excellence, the dandelion brings its enchantment and finesse into any environment. Glass door with digital decoration in white or black.*

Descrizione: vetro stampato digitale con disegno Dandelion spessore 5 + 5 mm - 10 mm /  
 Description: digitally printed glass with Dandelion pattern thickness 5+5 mm - 10 mm



### **Vetro**

Vetro trasparente extrachiaro  
*Extra-clear transparent glass*

Vetro satinato chiaro  
*Clear satin glass*

### **Stampato digitale** *Digitally printed*

**Bianco / White**

*Nero / Black*





**DANDELION**  
**vetro trasparente extrachiaro**  
*extra-clear transparent glass*



**DANDELION**  
**vetro satinato chiaro**  
*clear satin glass*

## Visual **DANDELION Black**

Simbolo di leggerezza e delicatezza per eccellenza, il soffione porta il suo incanto e la sua finezza in ogni ambiente. Porta a vetro con decorazione digitale in bianco o nero.

*Lightness and delicacy par excellence, the dandelion brings its enchantment and finesse into any environment. Glass door with digital decoration in white or black.*

Descrizione: vetro stampato digitale con disegno Dandelion spessore 5 + 5 mm - 10 mm /  
 Description: digitally printed glass with Dandelion pattern thickness 5+5 mm - 10 mm



### **Vetro**

Vetro trasparente extrachiaro  
*Extra-clear transparent glass*

Vetro satinato chiaro  
*Clear satin glass*

### **Stampato digitale** *Digitally printed*

Bianco / *White*

**Nero / *Black***





**LEAF**  
**vetro trasparente grigio**  
*vetro trasparente grigio*



**LEAF**  
**vetro satinato grigio**  
*grey satin glass*

## Visual LEAF

Un lieve accenno alla natura, come un soffice letto di foglie mosso dal vento. Per riscoprire il piacere della leggerezza. Porta a vetro con decorazione digitale tono su tono a tema natura.

*A faint hint of nature, resembling a soft bed of leaves tossed by the wind. Towards the pleasure of rediscovering lightness. Glass door with tone on tone digital decoration with a nature theme.*

Descrizione: vetro stampato digitale con disegno Leaf spessore 5+5 mm / *Description: digitally printed glass with Leaf pattern thickness 5+5 mm*

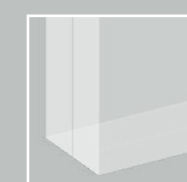

### Vetro

Vetro trasparente grigio  
*Transparent gray glass*

Vetro satinato grigio  
*Gray satin glass*

**Stampato digitale**  
*Digitally printed*

**Nero | Black**



# Natural

SPRING



Decoro Natura /  
*Nature pattern*

LEAF

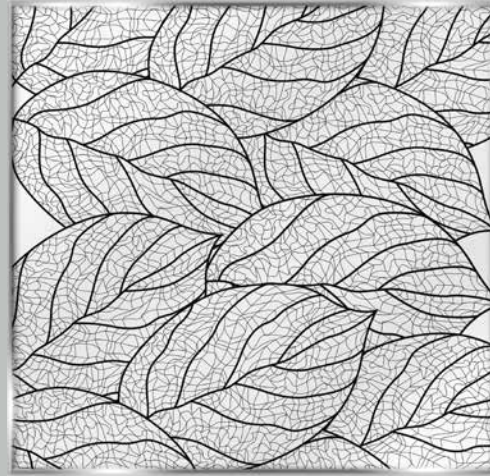

Decoro Natura nero /  
*Nature pattern black*

VALERY



Ocra / *Ocher*



Grigio chiaro / *Light grey*

DANDELION



Bianco / *White*



Nero / *Black*

VETRI NATURAL



# COLLEZIONE ZIONE

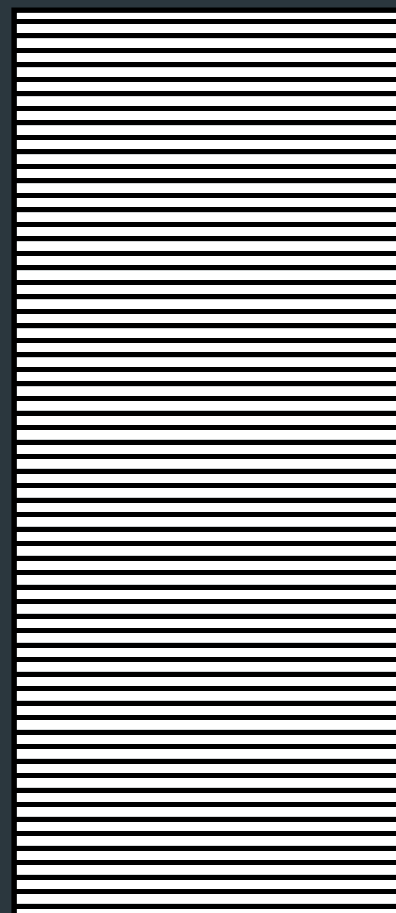

INDUSTRIAL DECOR horizontal

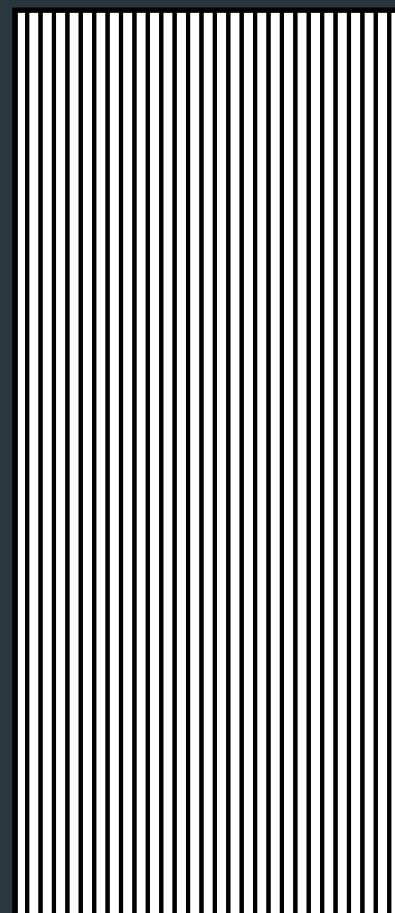

INDUSTRIAL DECOR vertical



MIRROR

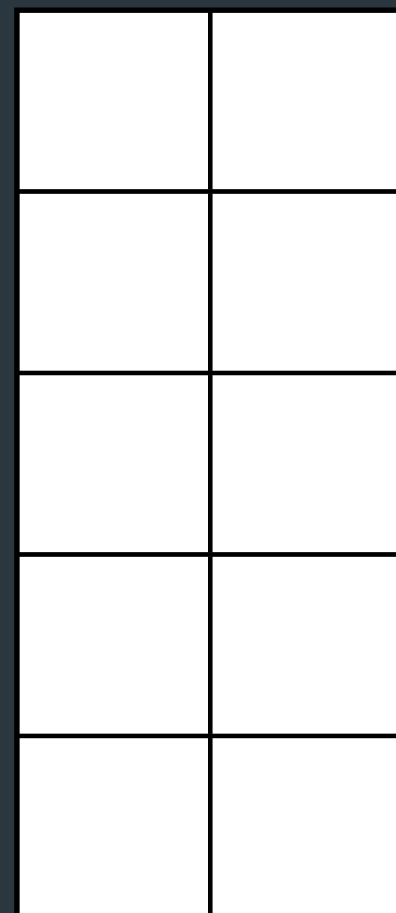

INDUSTRIAL CHIC DECOR

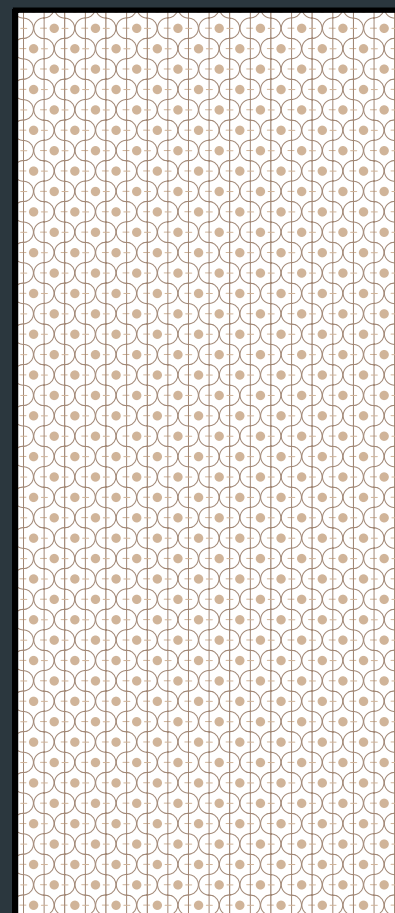

DEKO



STRIPES

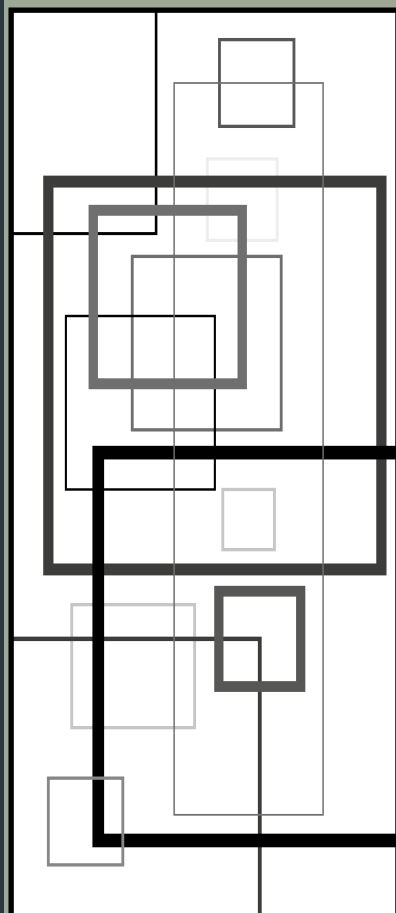

FRAME



SETA



MARMO BLACK vertical

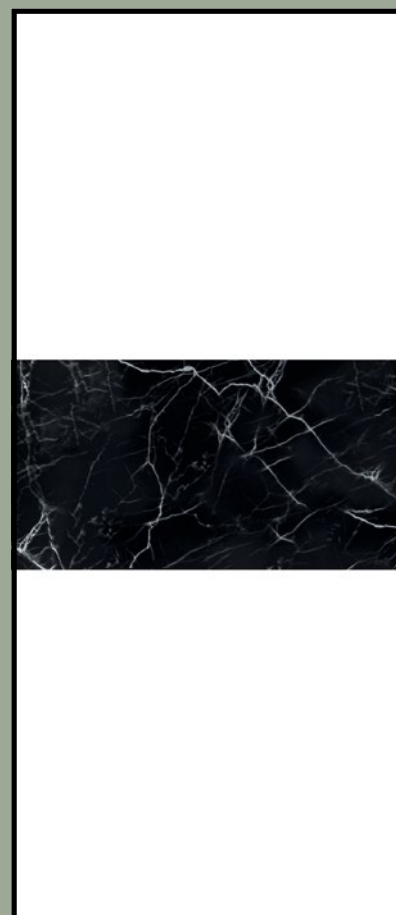

MARMO BLACK horizontal

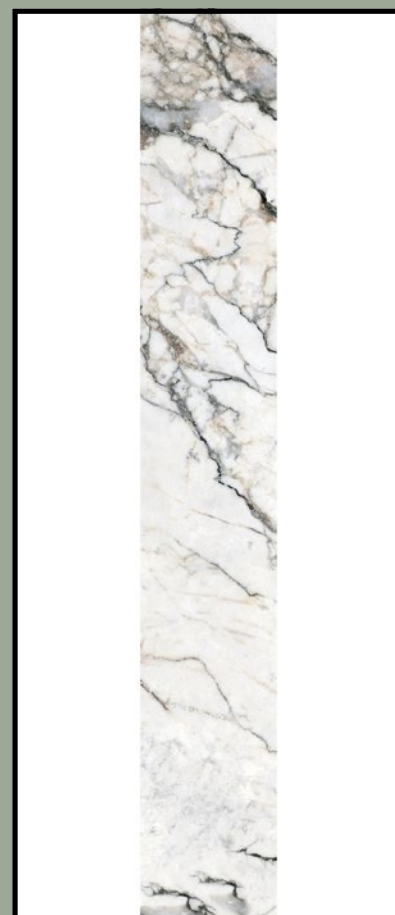

MARMO WHITE vertical

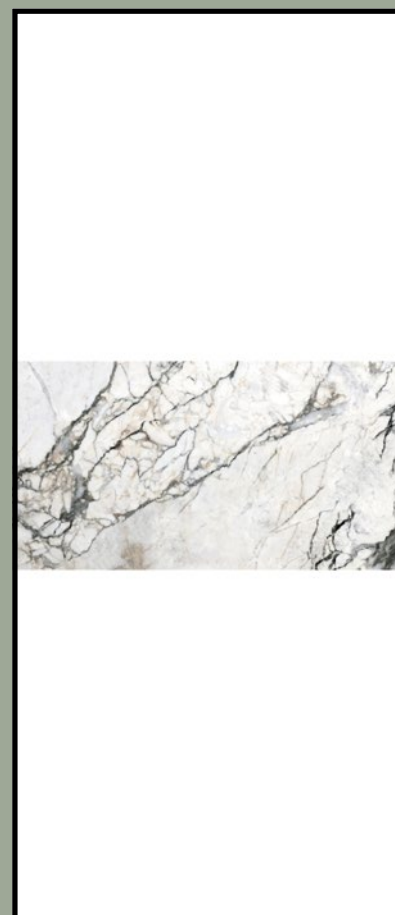

MARMO WHITE horizontal

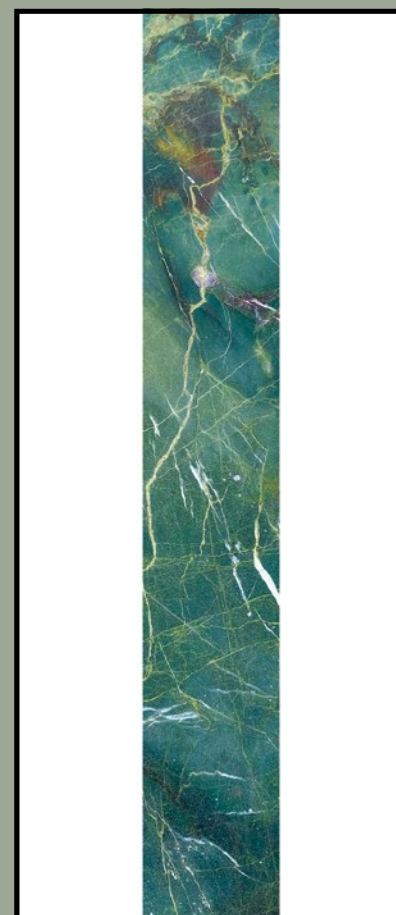

MARMO EMERALD vertical

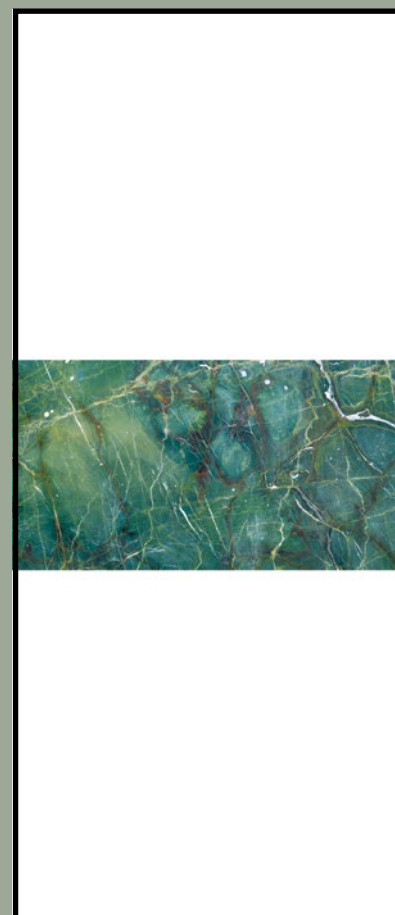

MARMO EMERALD horizontal



SPRING

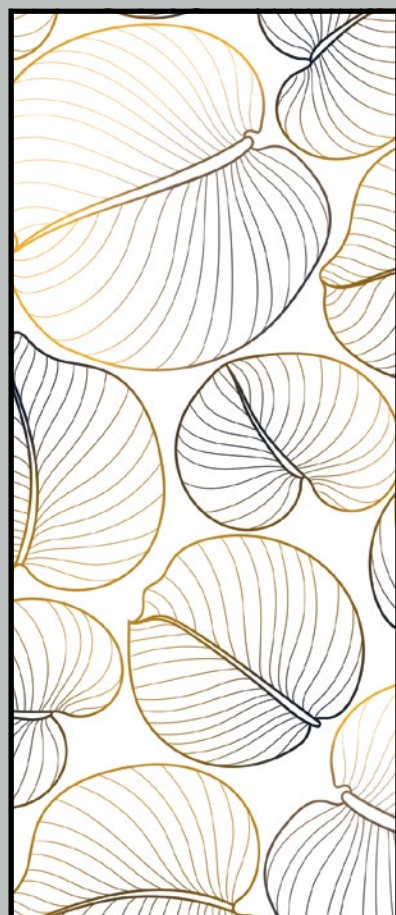

VALERY



DANDELION

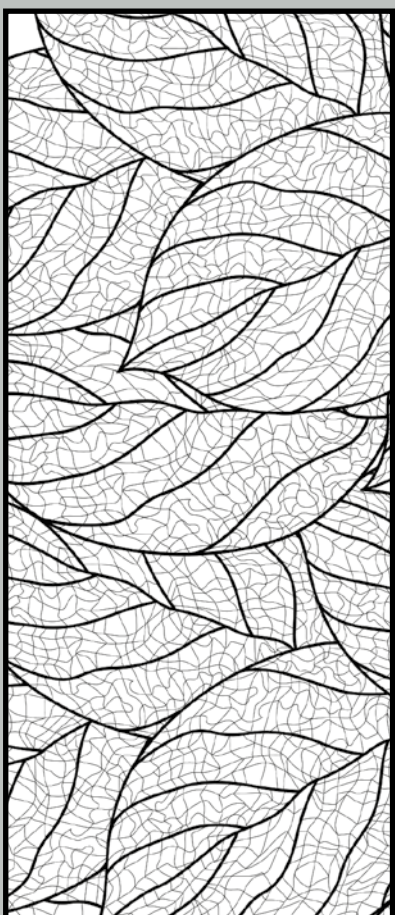

LEAF



## ACCESSORI E RICAMBI ANTA SCORREVOLE escluso modelli industrial

### GL 5

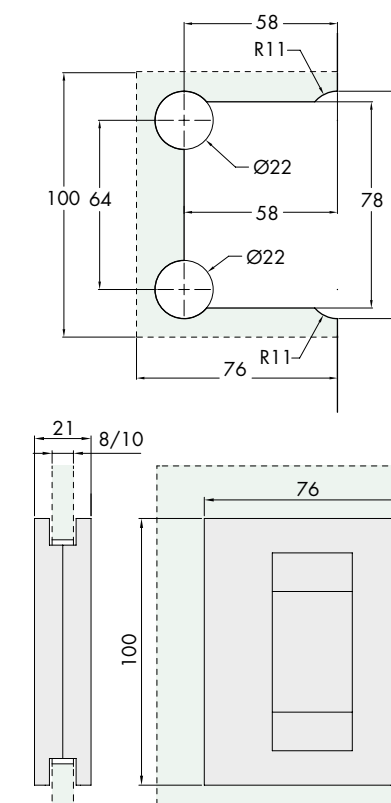

**Dimensioni**  
H 100 mm L 76 mm

**Vetro**  
8/10 mm

**Q.tà**  
1 Pz

Finitura cromo - acciaio satinato - alluminio opaco

*SLIDING DOOR ACCESSORIES AND SPARE PARTS  
(excluding industrial models)  
Chrome finish - satin steel - matt aluminium*

MANIGLIE

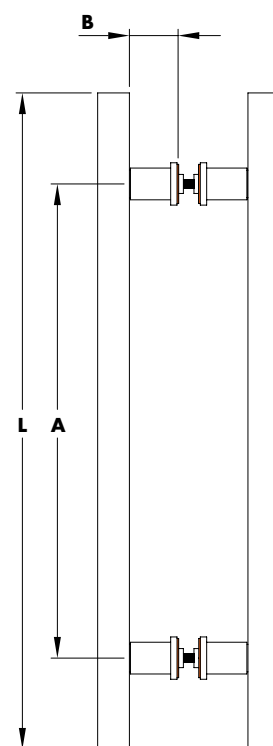

## GL 320

**Dimensioni**15 x 15 mm **L** 460 mm **A** 320 mm **B** 23 mm Ø**Foro vetro**

12 mm 6

**Per vetro**

/ 12 mm 1

**Q.tà**

Coppia

Finitura acciaio satinato - alluminio opaco - alluminio lucido  
*Satin steel finish - matt aluminum - polished aluminum*

## GL 2020

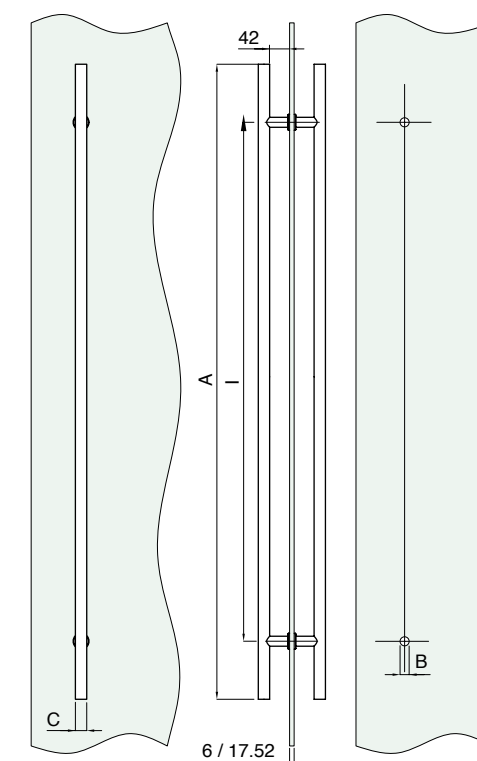
**Dimensioni****C** Ø20 mm **A** 300 mm **I** interasse 200 mm**Fori****B** minimo Ø12 mm**Vetro**

6/17.52 mm

**Q.tà**

Coppia

Finitura acciaio satinato - acciaio lucido  
*Satin steel finish - polished steel*

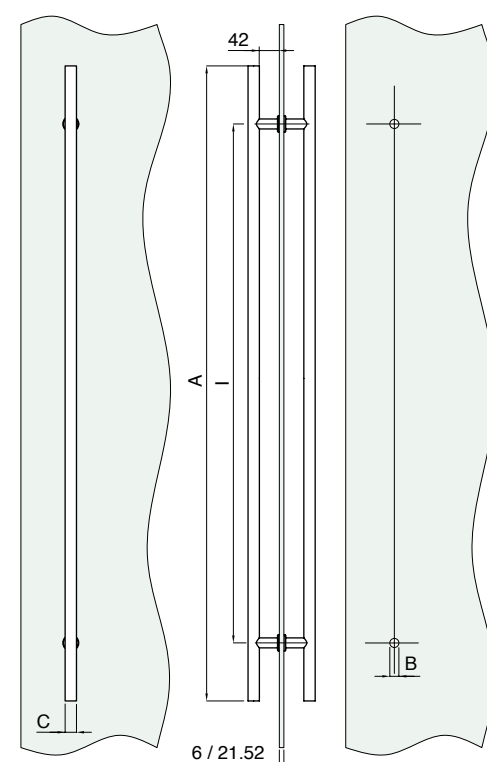

## GL 25300

**Dimensioni**

C Ø25 mm A 300 mm I interasse 200 mm

**Fori**

B minimo Ø14 mm

**Vetro**

6/21.52 mm

**Q.tà**

1 Coppia

Finitura acciaio satinato - acciaio lucido  
Satin steel finish - polished steel

## GLD - MATIQUE 66

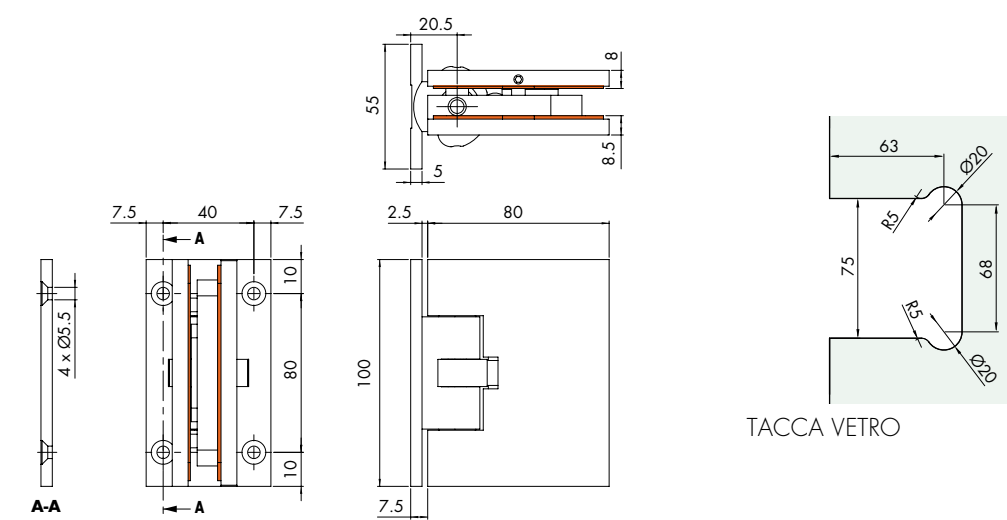
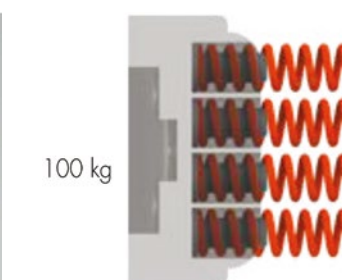
**Dimensioni**

L 80mm H 100mm

**Vetro**

10/12/6+6+1.52

**Portata**

100 kg

**Larghezza max porta**

900 mm

**Q.tà**

1 Pz

Cerniera vetro - muro finitura acciaio inox 304 - ottone  
Glass - wall hinge in 304 stainless steel - brass finish

CERNIERE



# ACCESSORI E RICAMBI ANTA SCORREVOLE

solo per i modelli industrial

## GM 008

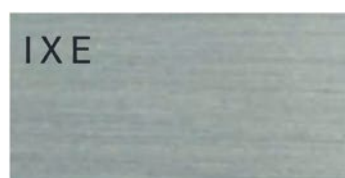
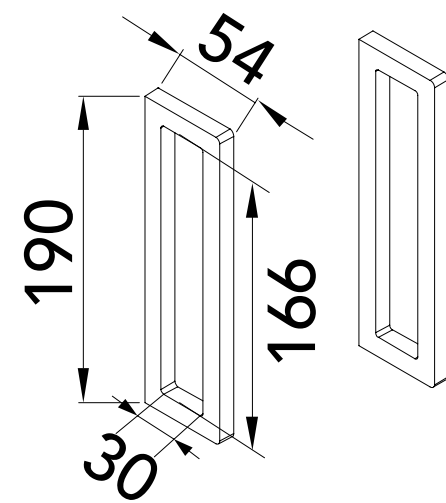

IXE  
ACCIAIO SATINATO  
INOX EFFECT

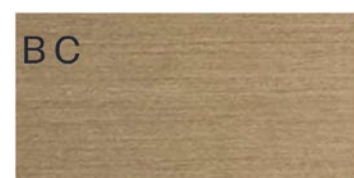

BC  
BRONZO CHIARO  
LIGHT BRONZE



BI  
BIANCO OPACO  
MATT WHITE

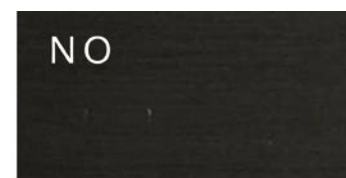

NO  
NERO OPACO  
MATT BLACK

**SLIDING DOOR ACCESSORIES AND SPARE PARTS**  
only for industrial

## GM 196

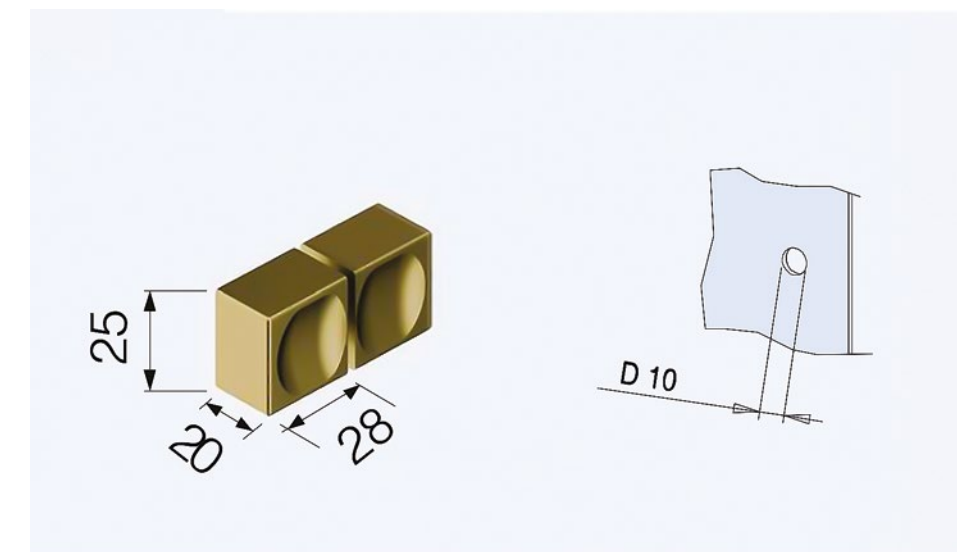

Finitura cromo - alluminio opaco - nero opaco  
Chrome finish - matt aluminum - matt black





GM 008 - BIANCO OPACO / MATT WHITE



GL 25300 - ACCIAIO LUCIDO / POLISHED STEEL



# Sistemi di apertura / *Opening systems*

Soluzioni disponibili / *Available solutions*

**PER PORTE DUE ANTE**  
*for two-leaf doors*

**GL 331** Sistemi scorrevoli - finitura acciaio satinato

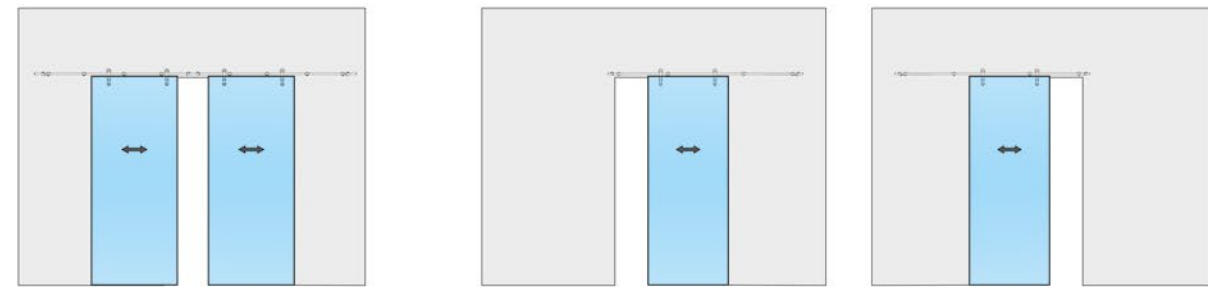

**GL 355** Sistemi scorrevoli - finitura acciaio satinato

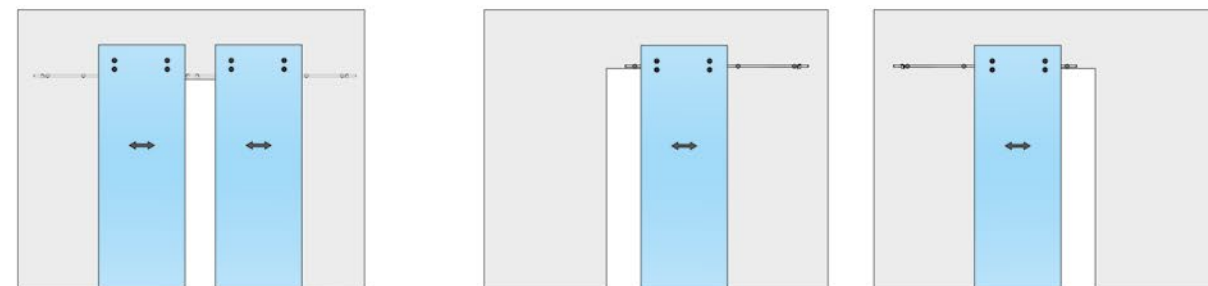

**GL 443** Sistemi scorrevoli - finitura acciaio satinato / alluminio lucido / alluminio opaco

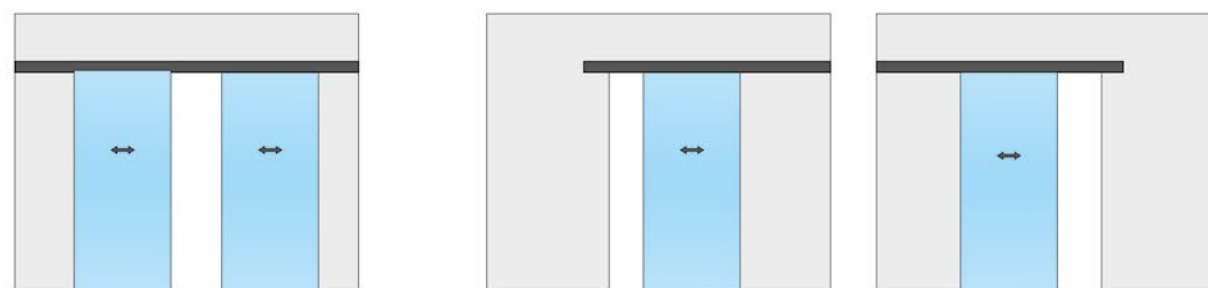

**GL 454** Sistemi scorrevoli - finitura acciaio satinato / alluminio lucido / alluminio opaco

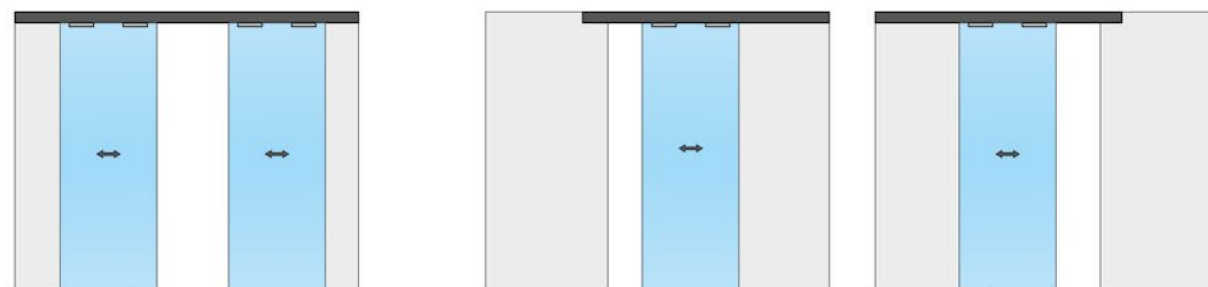

**PER PORTE UN'ANTA**  
*for single-leaf doors*

**GM 14 \*** Sistemi scorrevoli due ante  
finitura acciaio satinato/nero opaco/  
bronzo chiaro/bianco opaco

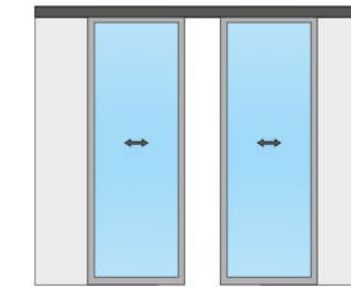

**GM 14 \*** Sistemi scorrevoli un'anta  
finitura acciaio satinato/nero opaco/  
bronzo chiaro/bianco opaco

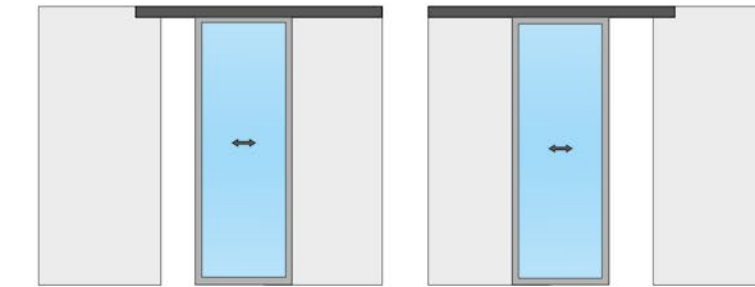

**GL 328** Sistemi scorrevoli un'anta  
finitura acciaio satinato

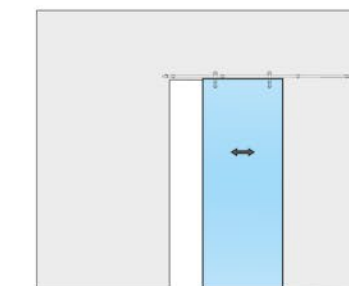

**GL 448** Sistemi scorrevoli due ante  
finitura acciaio satinato / alluminio lucido / alluminio opaco

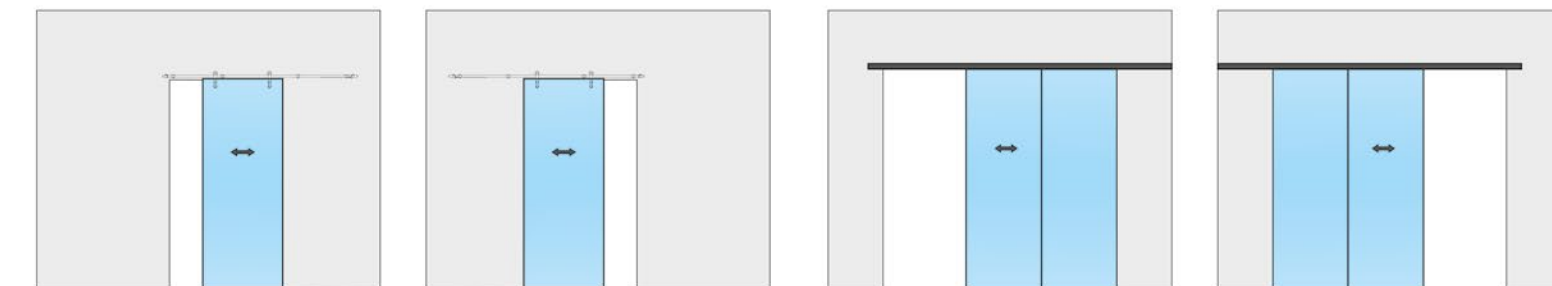

**GLD MATIQUE 66** Sistema battente un'anta  
finitura acciaio satinato / alluminio opaco / cromo

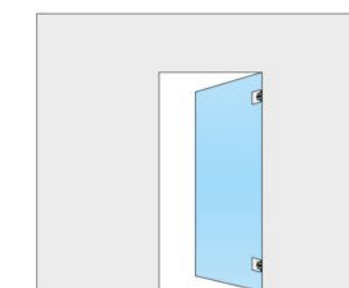

**GLD MATIQUE 66** Sistema battente due ante  
finitura acciaio satinato / alluminio opaco/cromo

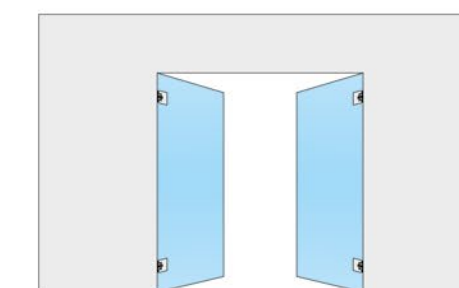

*GL 331 Sliding systems - satin steel finish*

*GL 355 Sliding systems - satin steel finish*

*GL 433 Sliding systems - satin steel finish / polished aluminium / matt aluminium*

*GL 454 Sliding systems - satin steel finish / polished aluminium / matt aluminium*

*GM 14 \* Double-leaf sliding systems satin steel finish matt black / light bronze / matt white*

*GM 14 \* Single-leaf sliding systems satin steel finish matt black / light bronze / matt white*

*GL 328 Single-leaf sliding systems / satin steel finish*

*GL 448 Double-leaf sliding systems / satin steel / polished aluminium / matt aluminium finish.*

*GLD MATIQUE 66 Single-leaf hinged systems / satin steel / matt aluminium / chrome finish.*

*GLD MATIQUE 66 Double-leaf hinged system / satin steel / matt aluminium / chrome finish*

*\*solo per i modelli Urban / For urban models only*



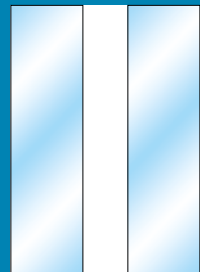

# GL 331

## APERTURA SCORREVOLE ESTERNO MURO DUE ANTE CONTRAPPOSTE OUTWARD SLIDING OPENING TWO OPPOSING LEAVES

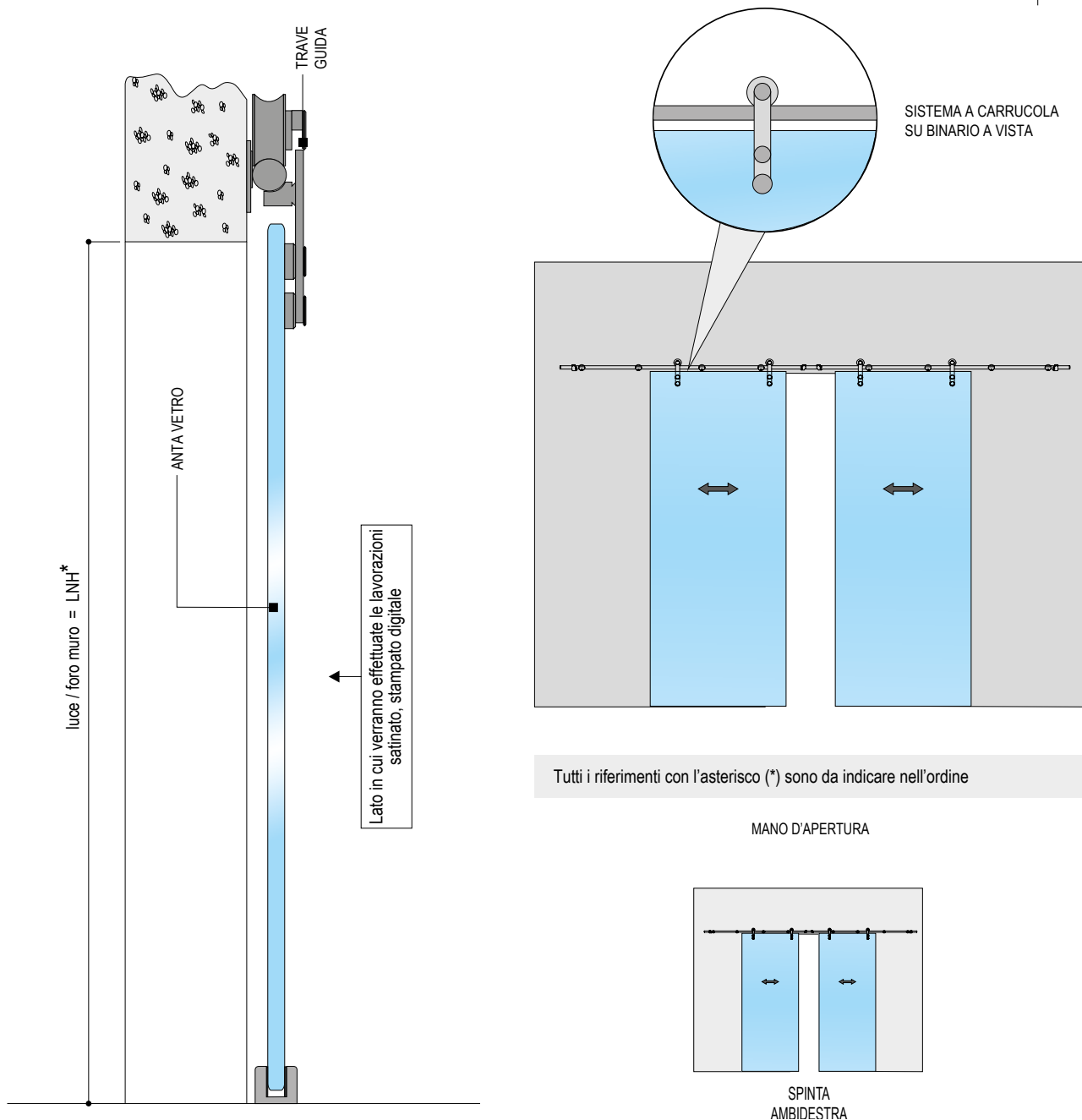
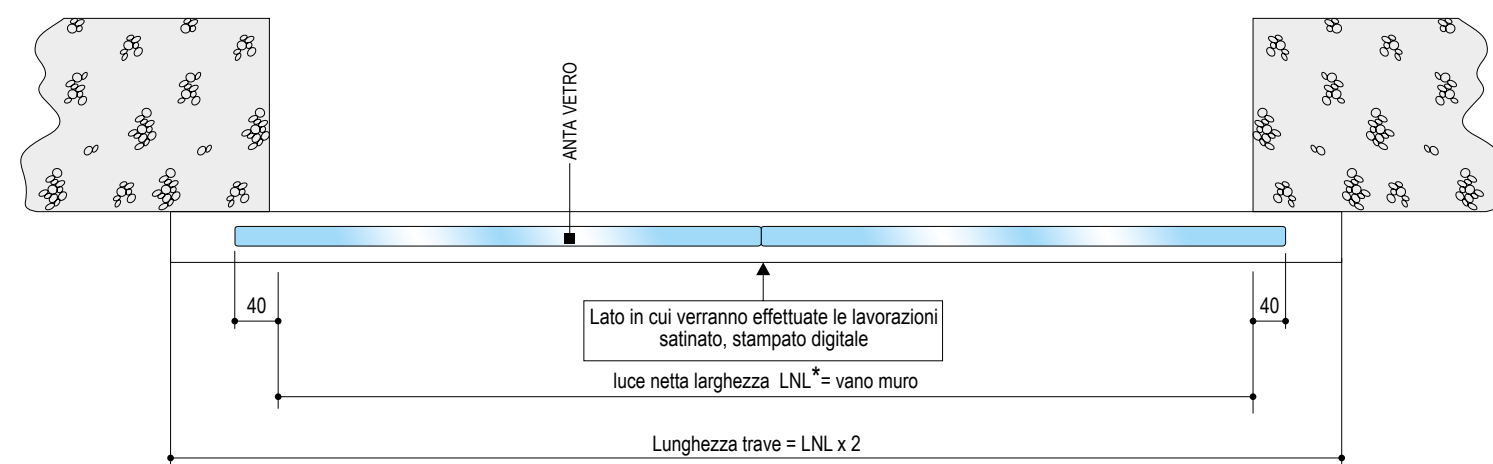

Tutti i riferimenti con l'asterisco (\*) sono da indicare nell'ordine

# GL 331

## APERTURA SCORREVOLE ESTERNO MURO AD UN'ANTA OUTWARD SLIDING OPENING SINGLE LEAF

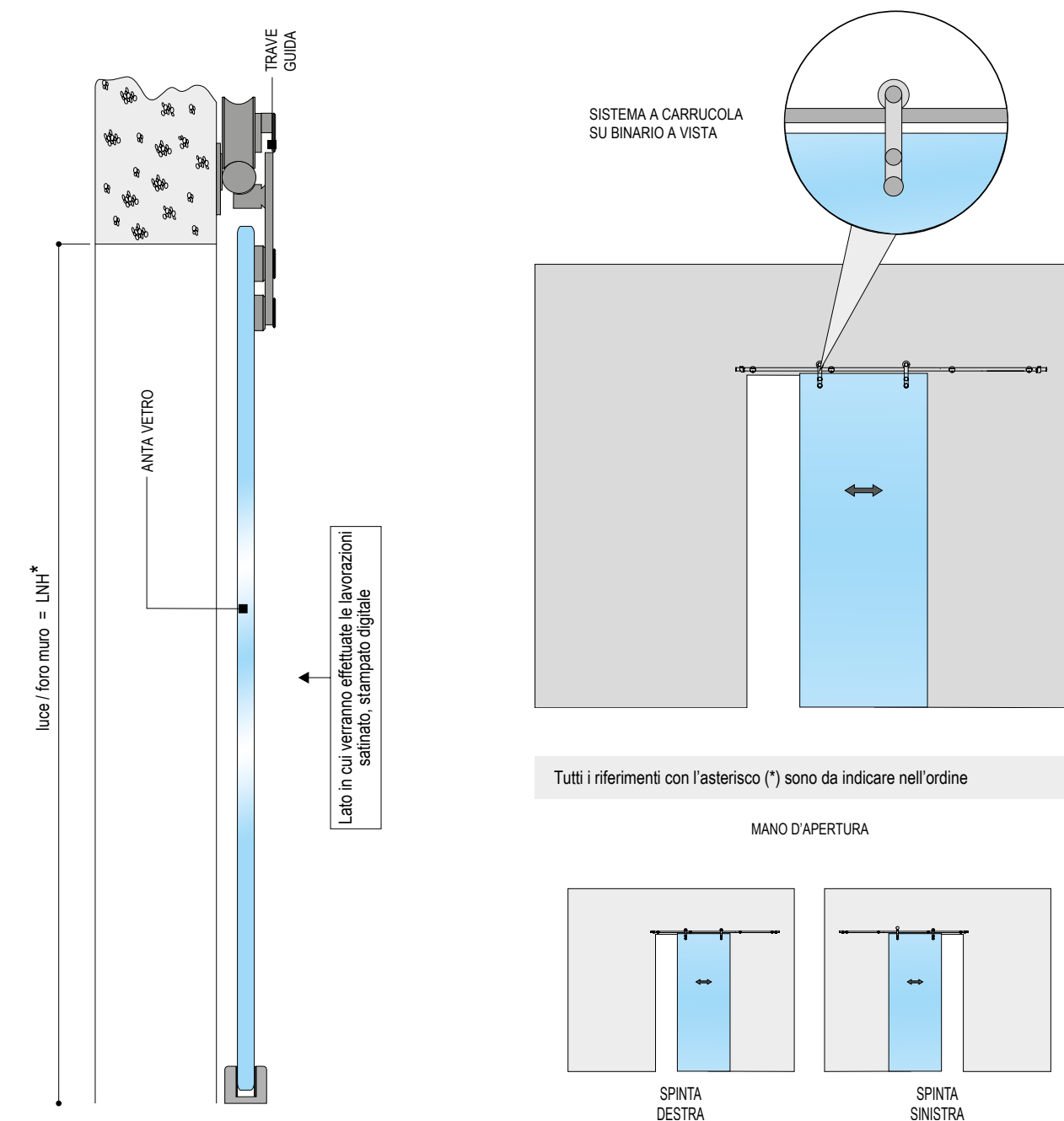
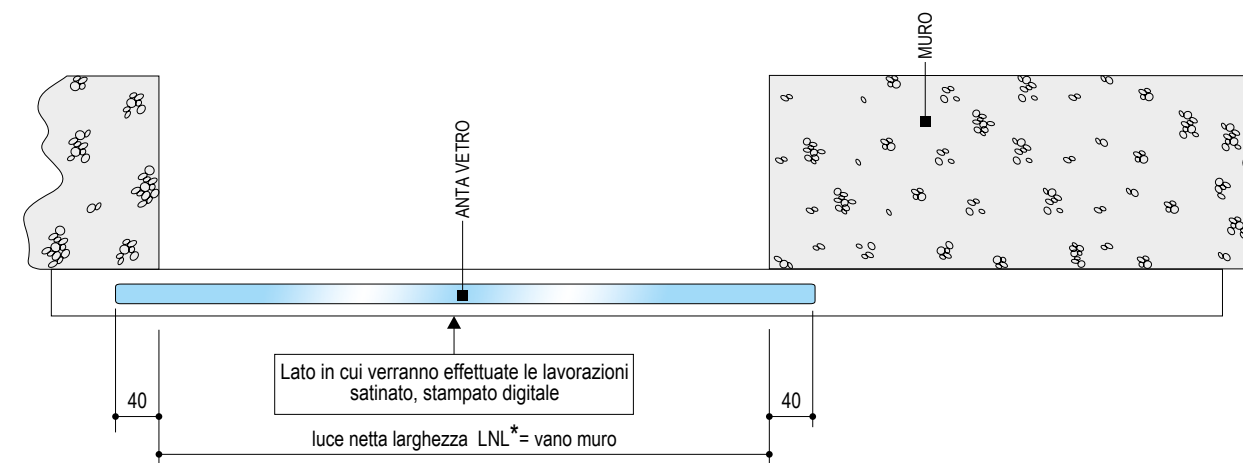

Tutti i riferimenti con l'asterisco (\*) sono da indicare nell'ordine





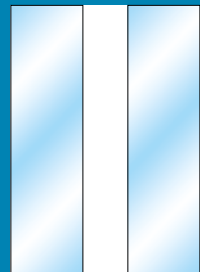

# GL 355

## APERTURA SCORREVOLE ESTERNO MURO DUE ANTE CONTRAPPOSTE OUTWARD SLIDING OPENING TWO OPPOSING LEAVES

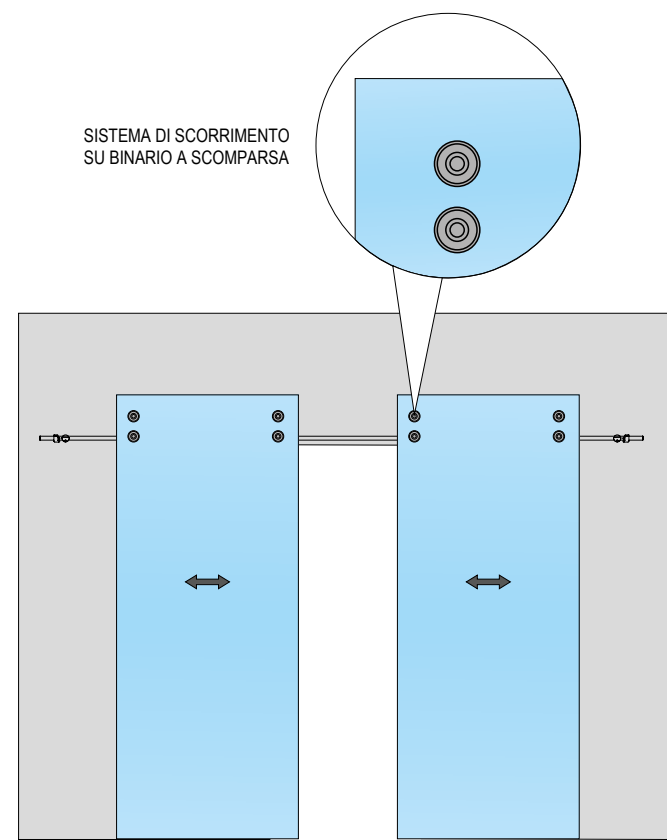
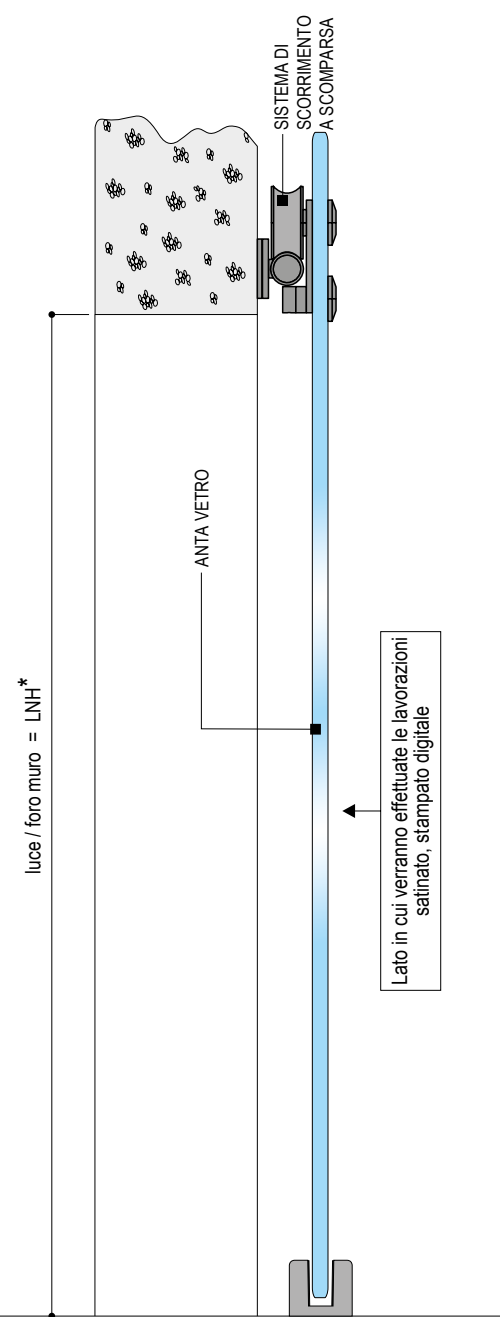
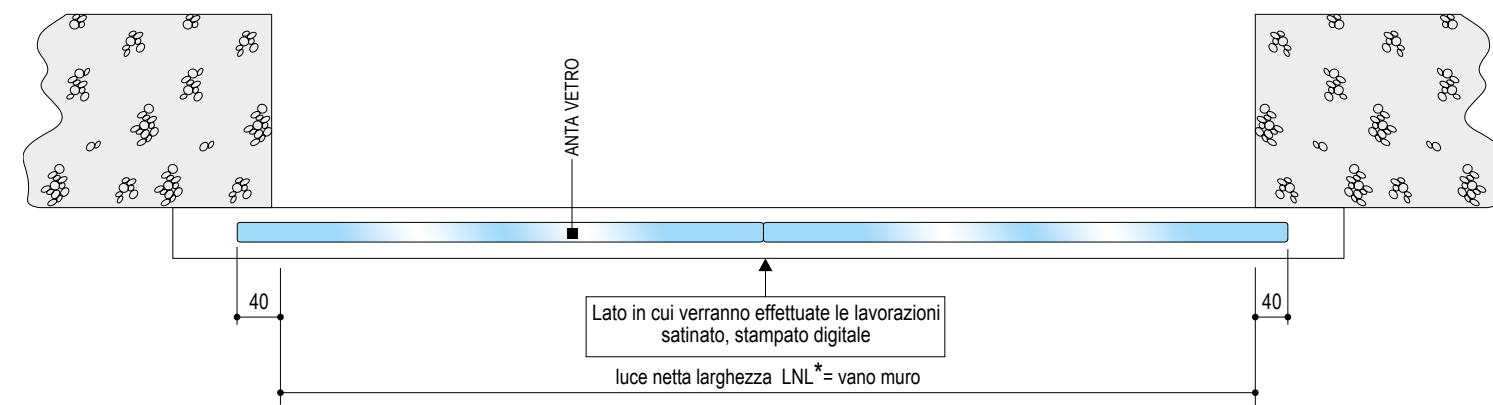

Tutti i riferimenti con l'asterisco (\*) sono da indicare nell'ordine

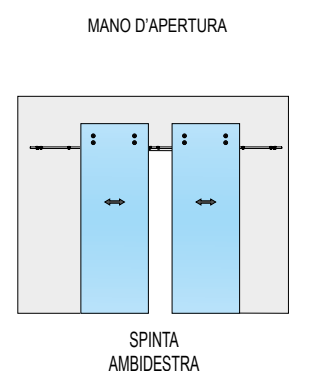

# GL 355

## APERTURA SCORREVOLE ESTERNO MURO AD UN'ANTA OUTWARD SLIDING OPENING SINGLE LEAF

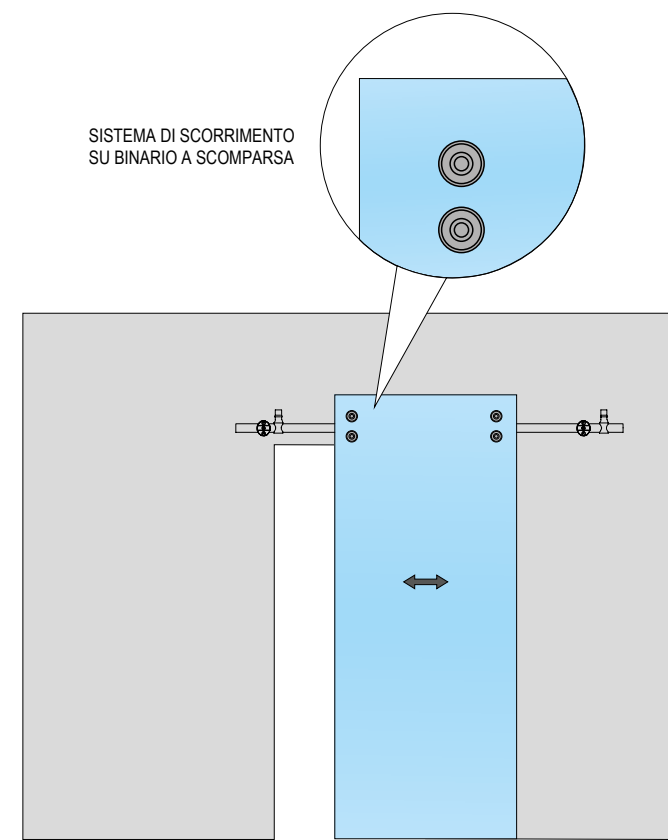
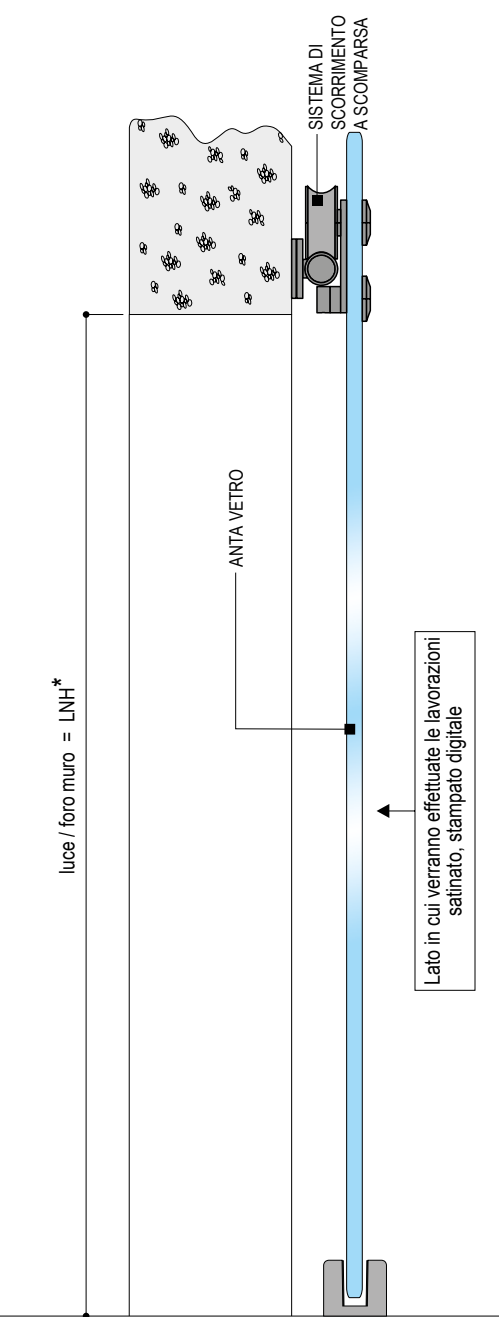
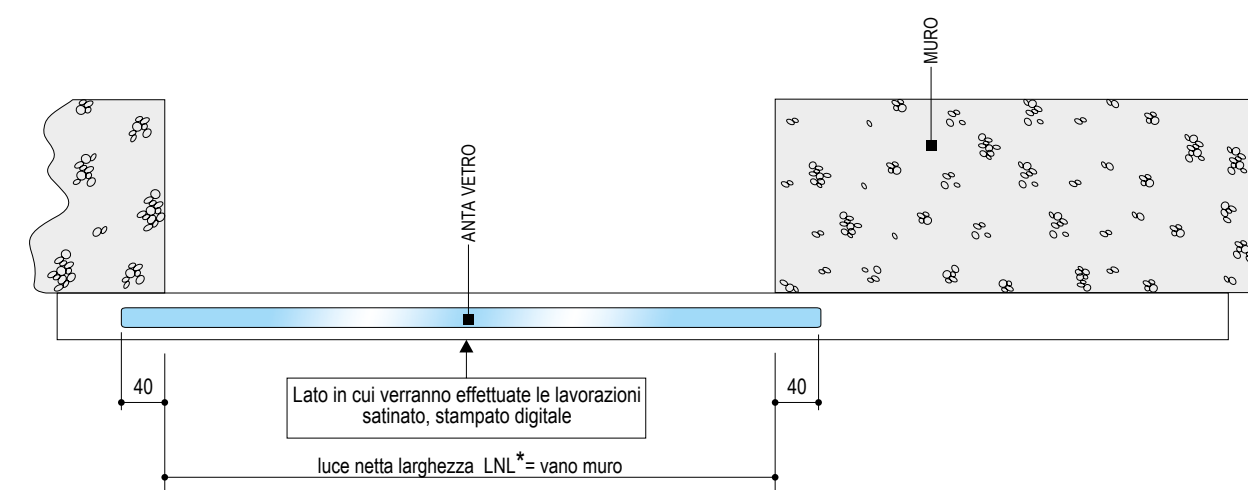

Tutti i riferimenti con l'asterisco (\*) sono da indicare nell'ordine

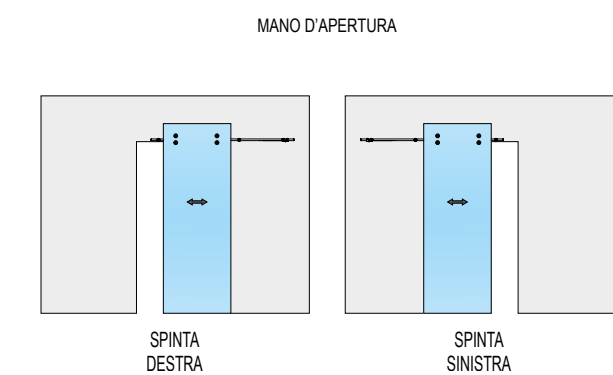

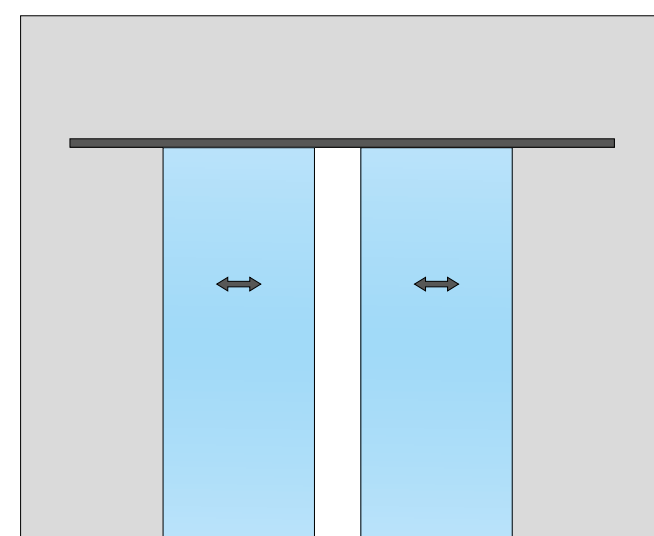
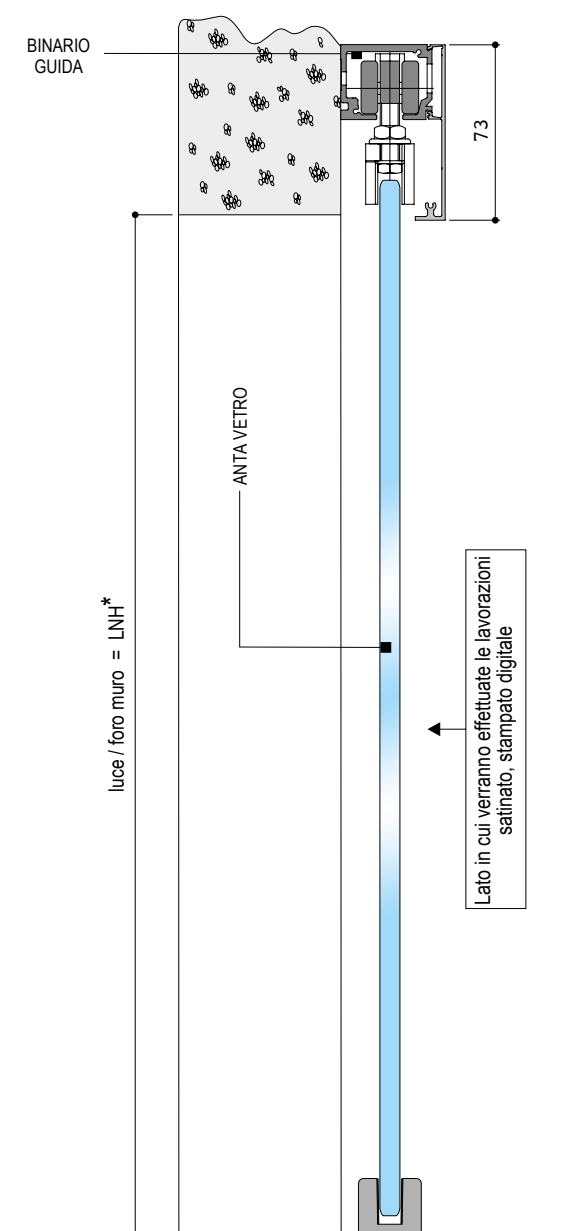
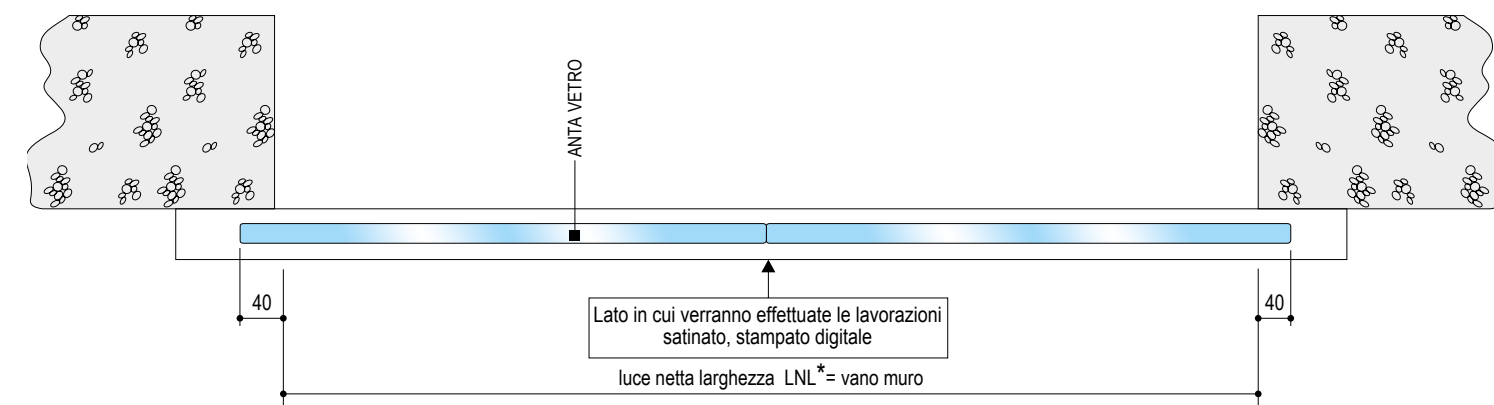

**GL 443****APERTURA SCORREVOLE ESTERNO MURO DUE ANTE CONTRAPPOSTE**  
*OUTWARD SLIDING OPENING TWO OPPOSING LEAVES*

Tutti i riferimenti con l'asterisco (\*) sono da indicare nell'ordine

MANO D'APERTURA

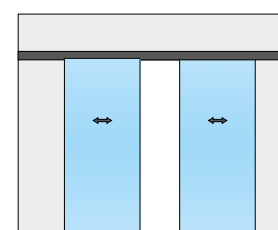

SPINTA  
AMBIDESTRA

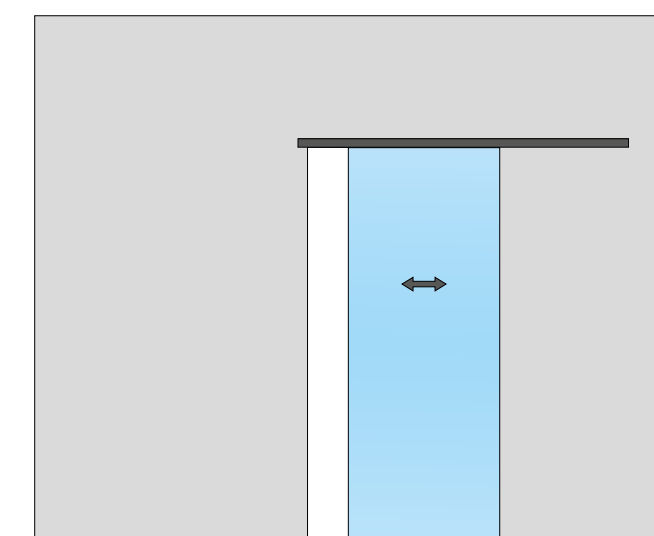
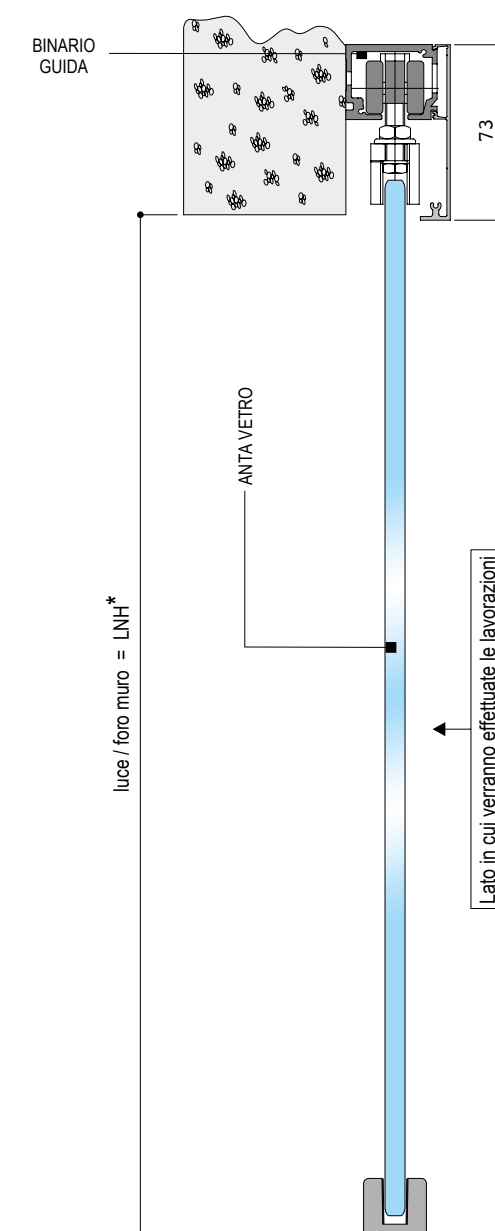
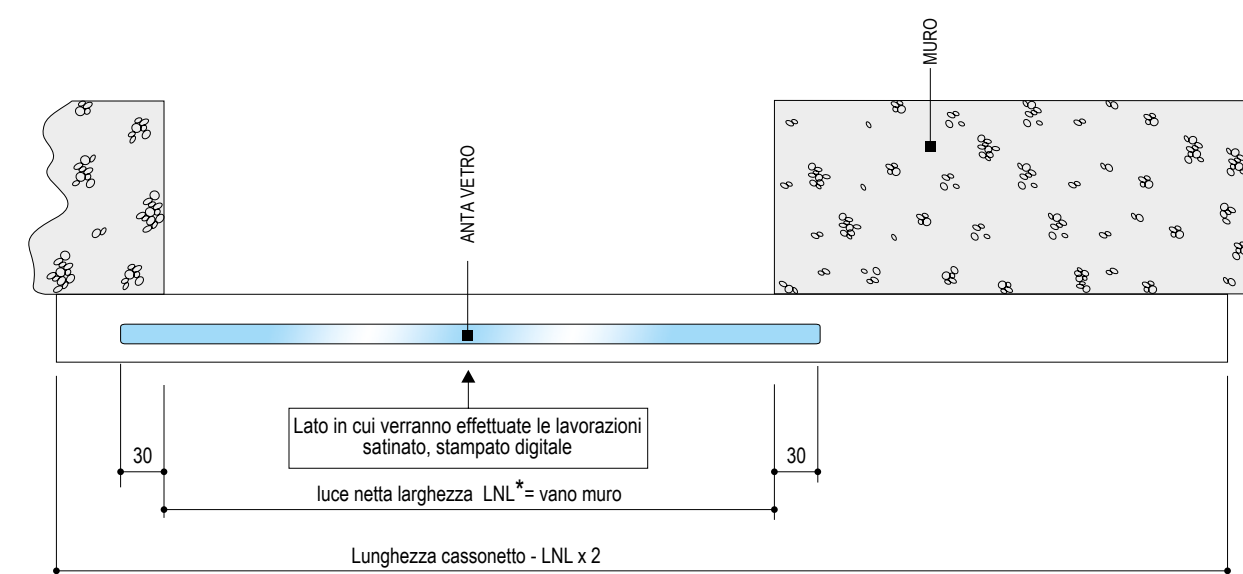
**GL 443****APERTURA SCORREVOLE ESTERNO MURO AD UN'ANTA**  
*OUTWARD SLIDING OPENING SINGLE LEAF*

Tutti i riferimenti con l'asterisco (\*) sono da indicare nell'ordine

MANO D'APERTURA

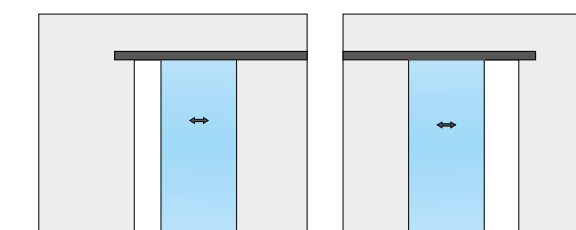

SPINTA  
DESTRA

SPINTA  
SINISTRA



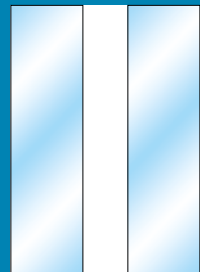

# GL 454

## APERTURA SCORREVOLE ESTERNO MURO DUE ANTE CONTRAPPOSTE OUTWARD SLIDING OPENING TWO OPPOSING LEAVES

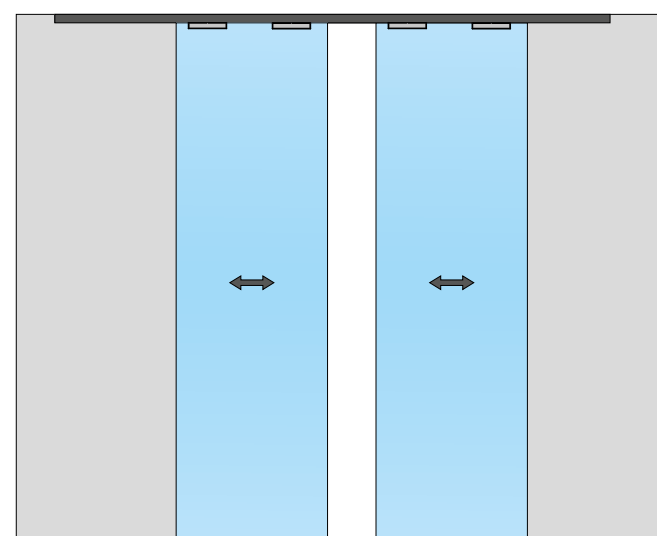
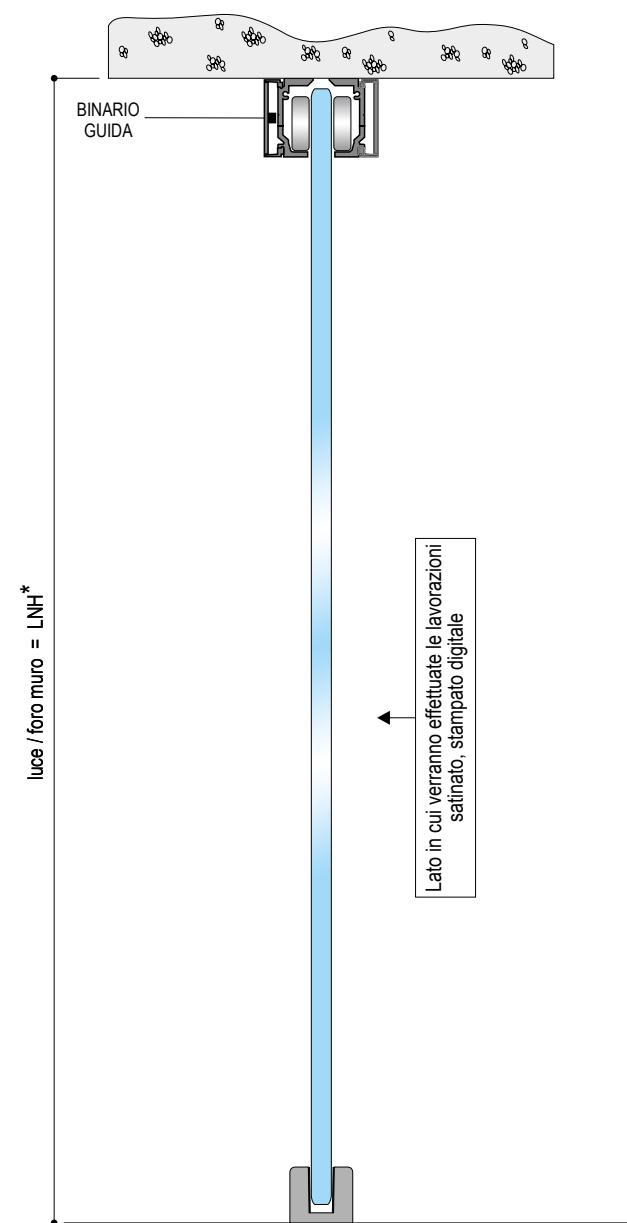
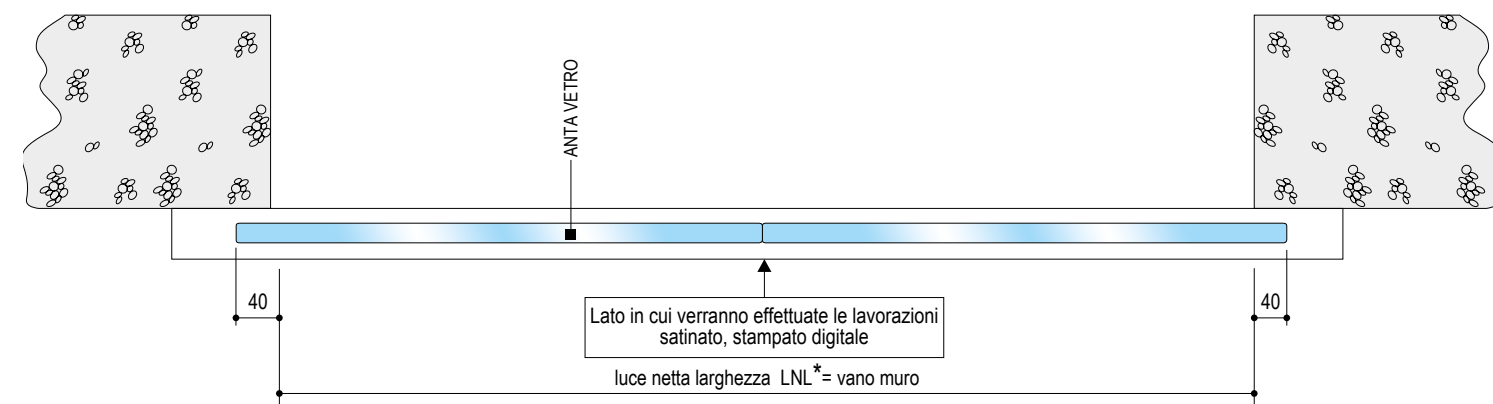

Tutti i riferimenti con l'asterisco (\*) sono da indicare nell'ordine

MANO D'APERTURA

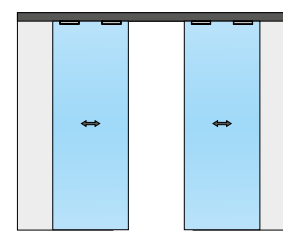

SPINTA  
AMRIDFESTRA

# GL 454

## APERTURA SCORREVOLE ESTERNO MURO AD UN'ANTA OUTWARD SLIDING OPENING SINGLE LEAF

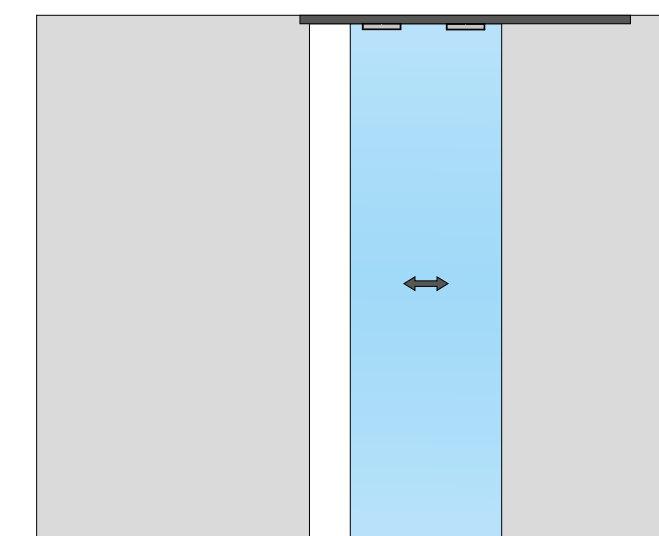
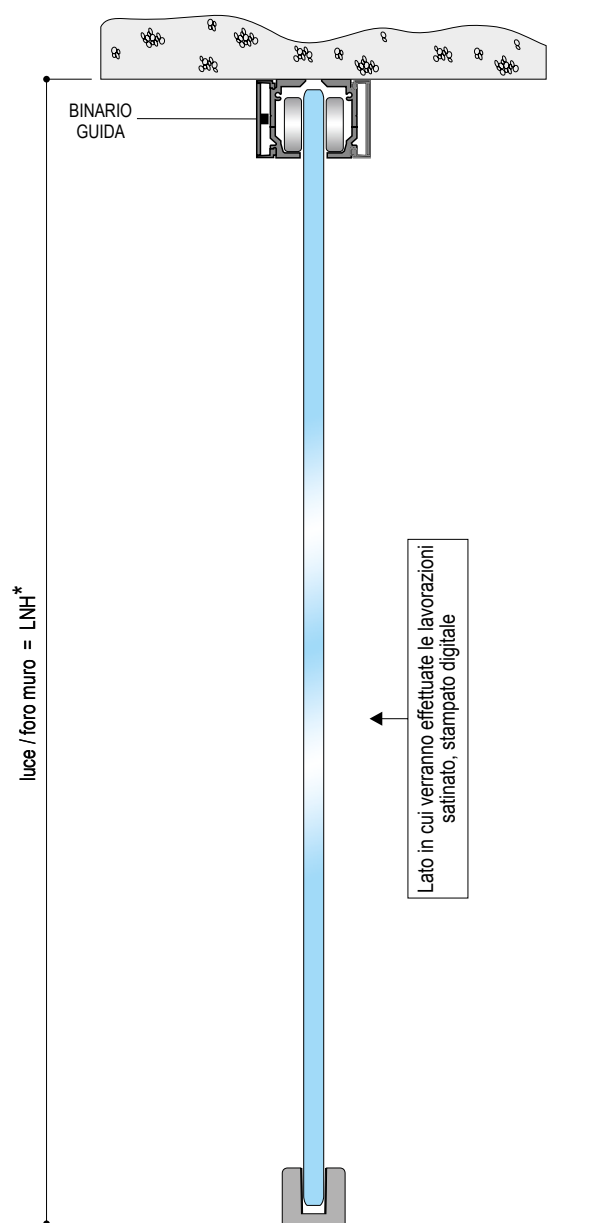
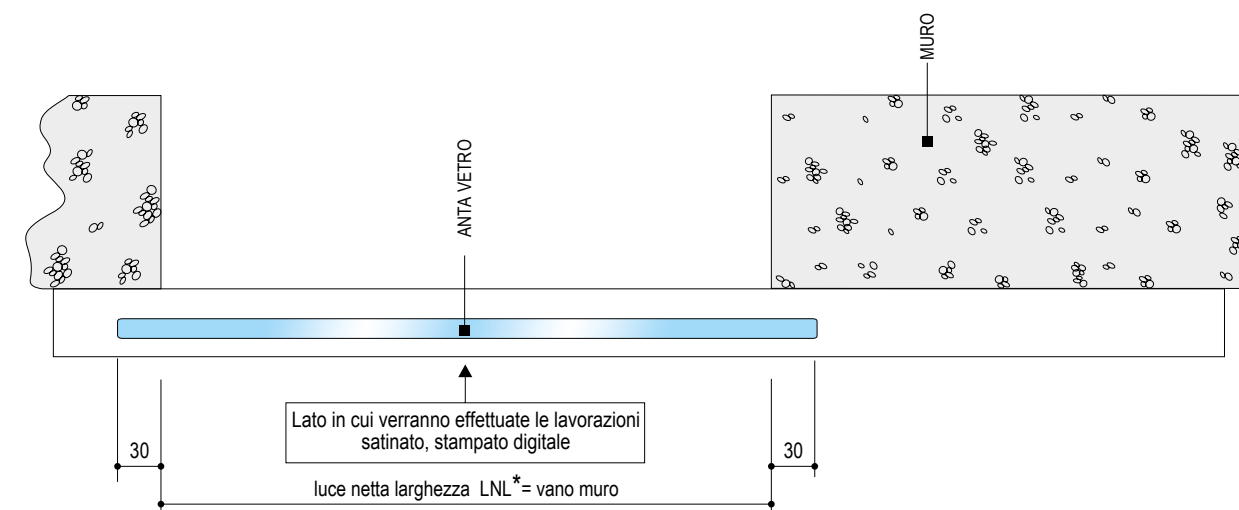

Tutti i riferimenti con l'asterisco (\*) sono da indicare nell'ordine

MANO D'APERTURA

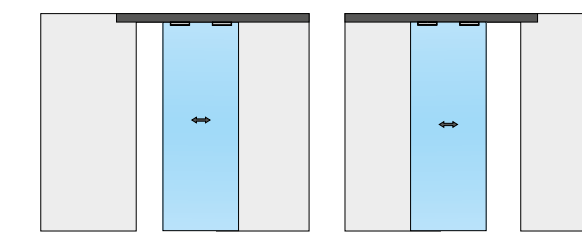

SPINTA  
DESTRA

SPINTA  
SINISTRA





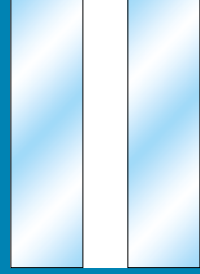

# GM14

## APERTURA SCORREVOLE ESTERNO MURO DUE ANTE CONTRAPPOSTE OUTWARD SLIDING OPENING TWO OPPOSING LEAVES

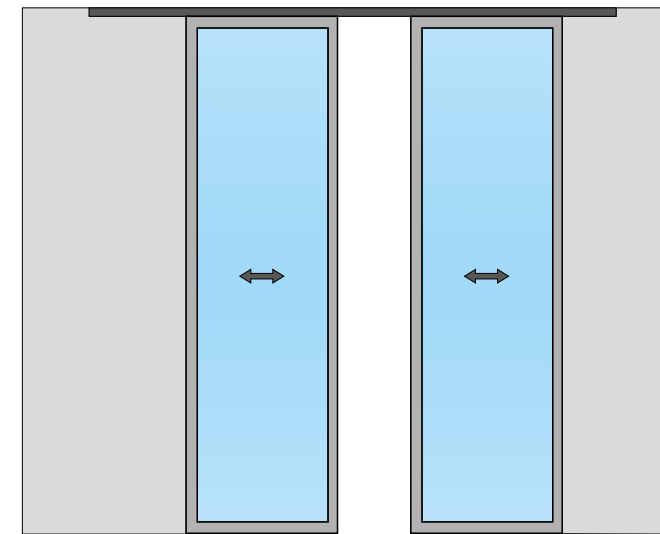
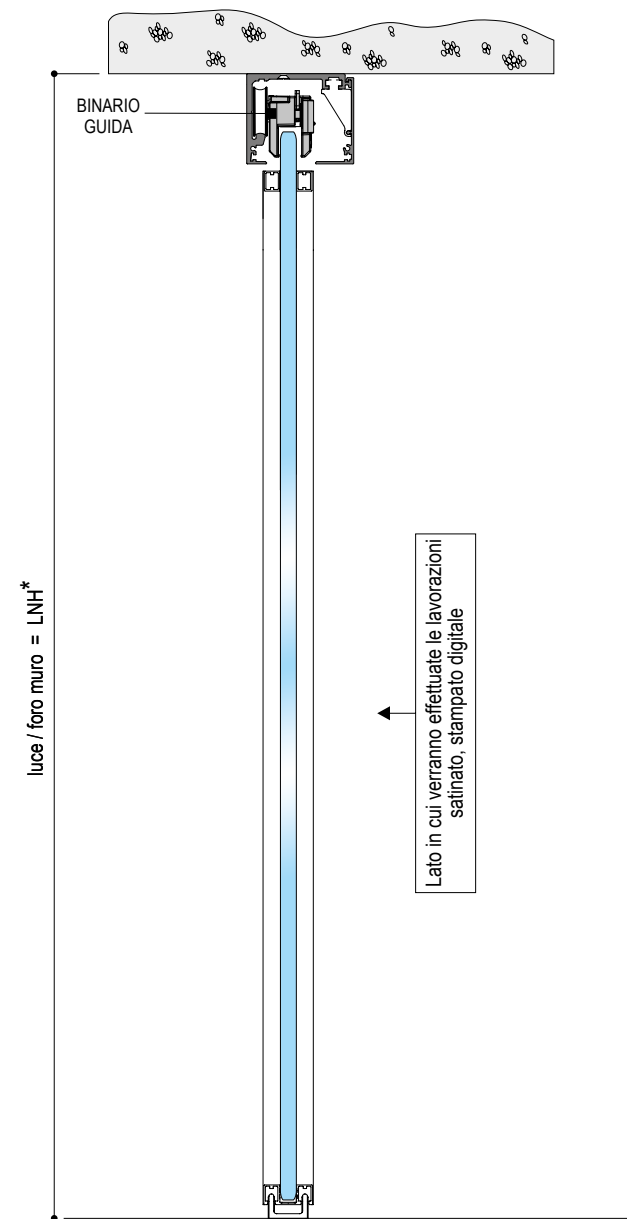
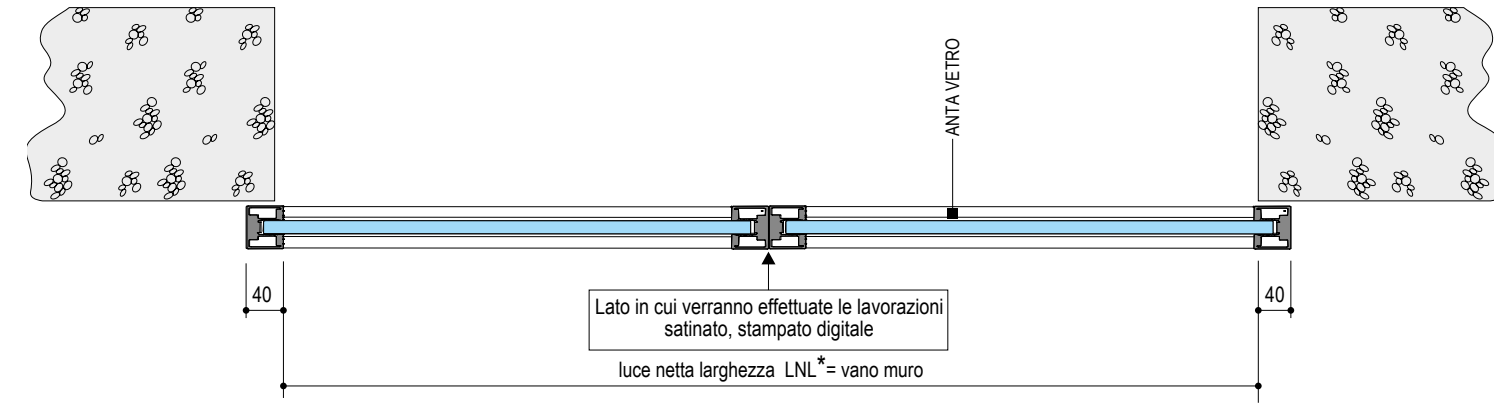

Tutti i riferimenti con l'asterisco (\*) sono da indicare nell'ordine

MANO D'APERTURA

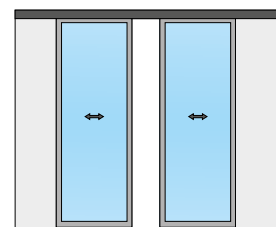

SPINTA  
AMBIDESTRA

# GM14

## APERTURA SCORREVOLE ESTERNO MURO AD UN'ANTA OUTWARD SLIDING OPENING SINGLE LEAF

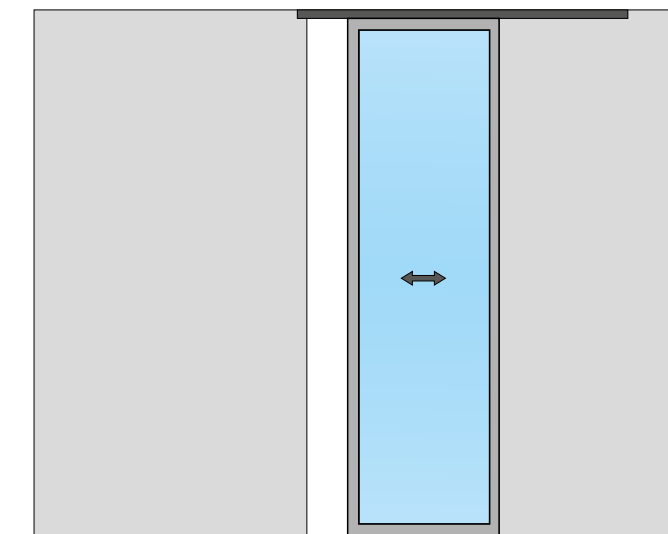
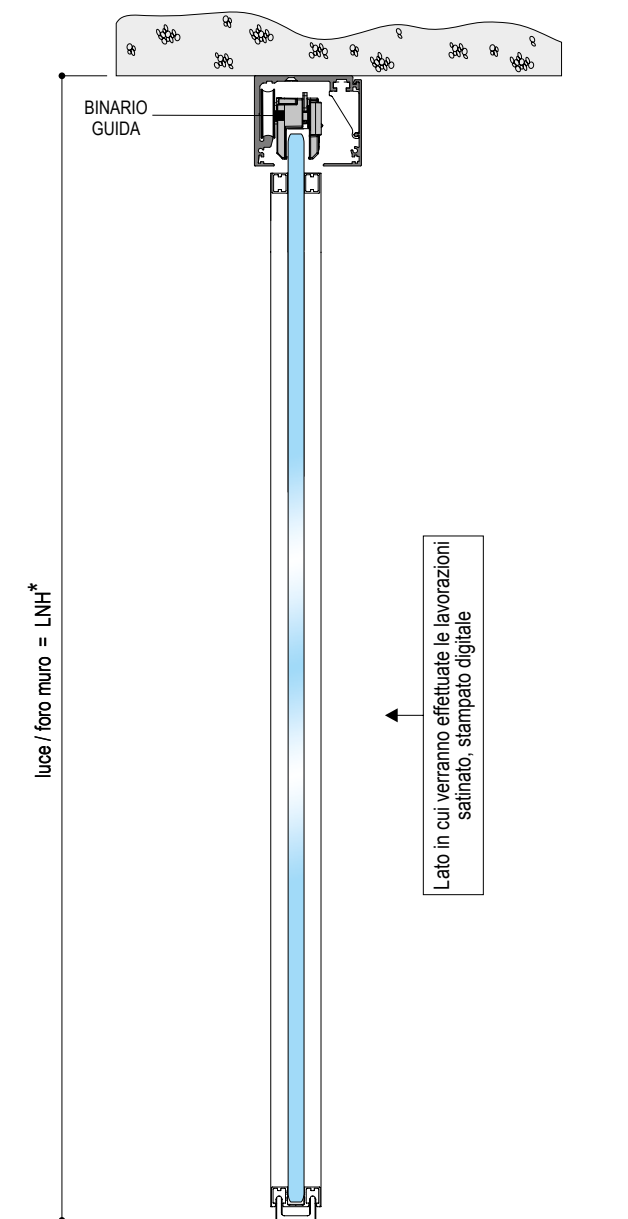
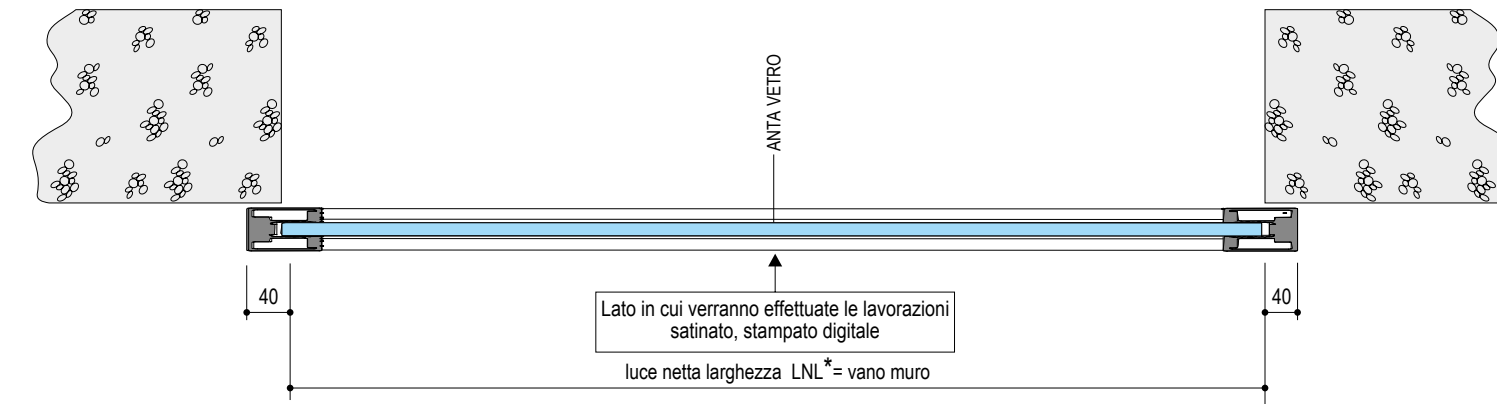

Tutti i riferimenti con l'asterisco (\*) sono da indicare nell'ordine

MANO D'APERTURA

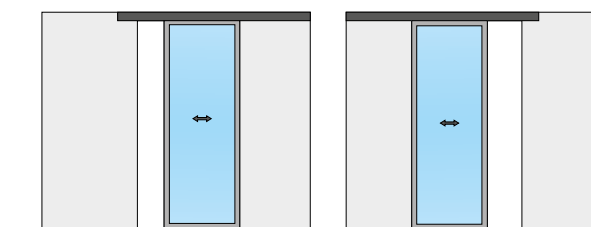

SPINTA  
DESTRA

SPINTA  
SINISTRA





# GL 328

APERTURA SCORREVOLE ESTERNO MURO AD UN'ANTA  
 OUTWARD SLIDING OPENING SINGLE LEAF

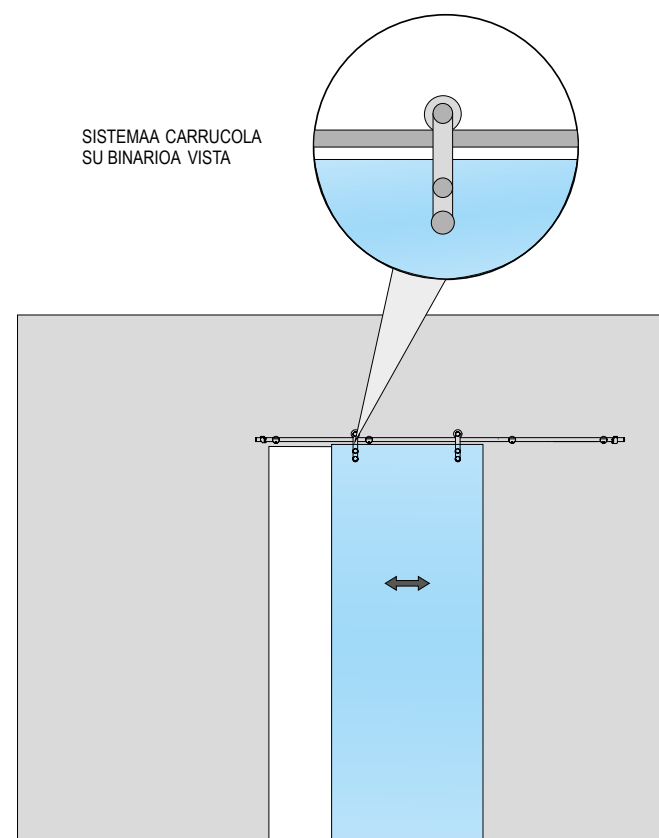
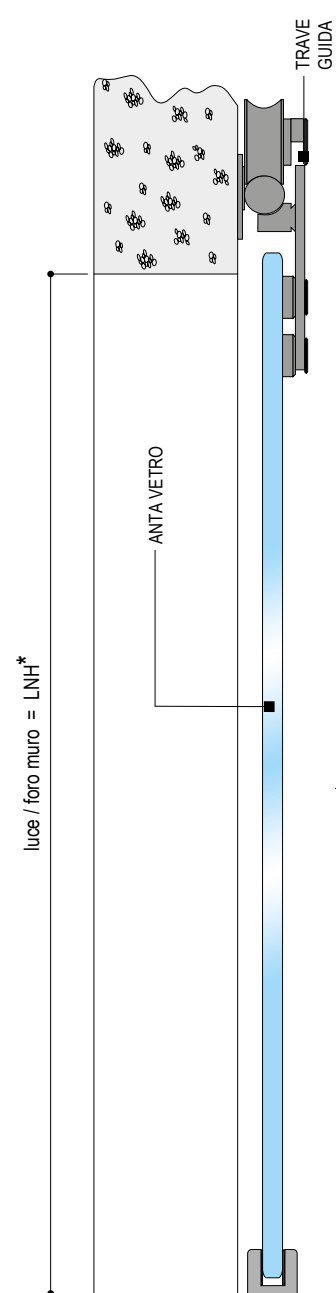
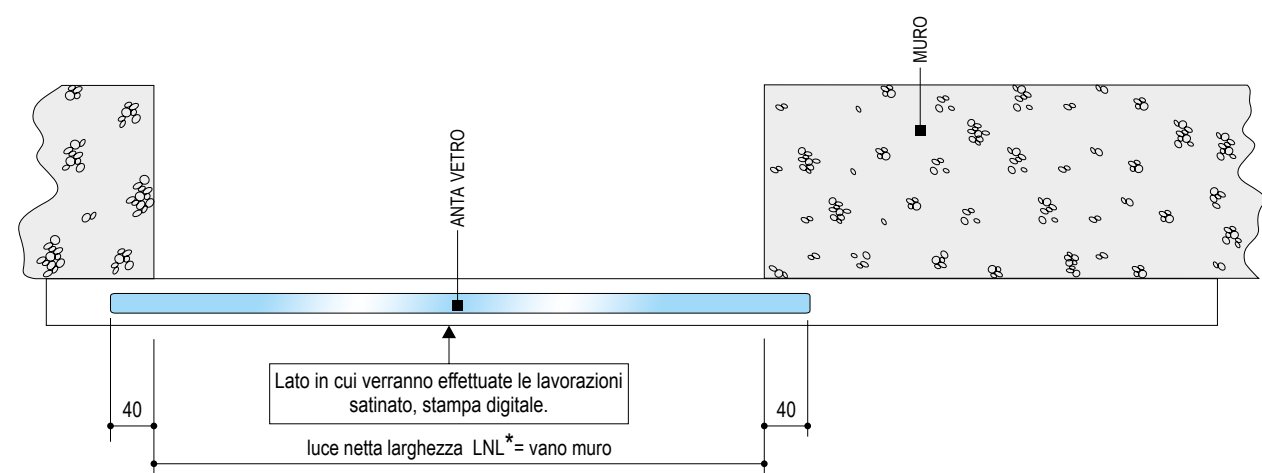

Tutti i riferimenti con l'asterisco (\*) sono da indicare nell'ordine

MANO D'APERTURA

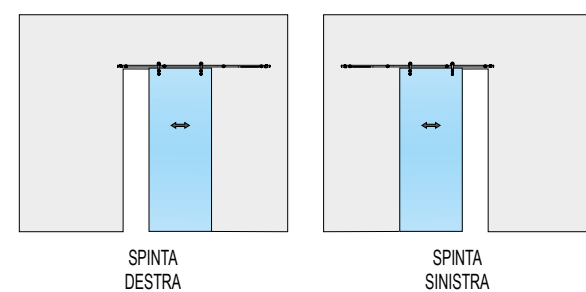

# GL 448

APERTURA SCORREVOLE ESTERNO MURO DUE ANTE 1 ANTA FISSA + 1 ANTA SCORREVOLE  
 OUTWARD SLIDING OPENING TWO LEAVES 1 FIXED LEAF + 1 SLIDING LEAF

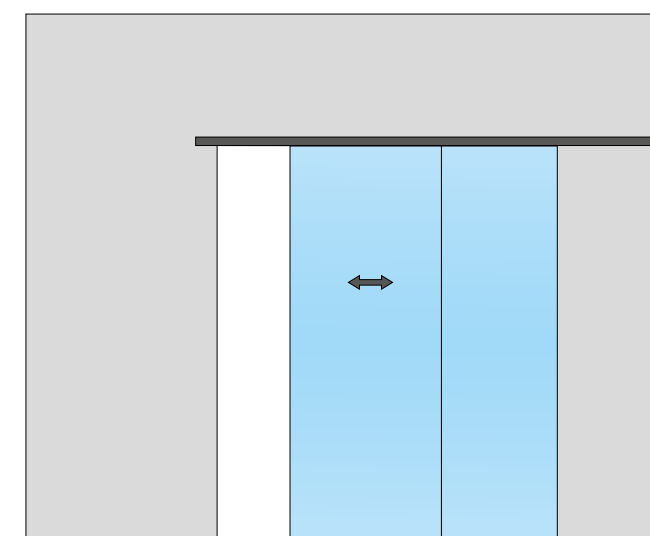
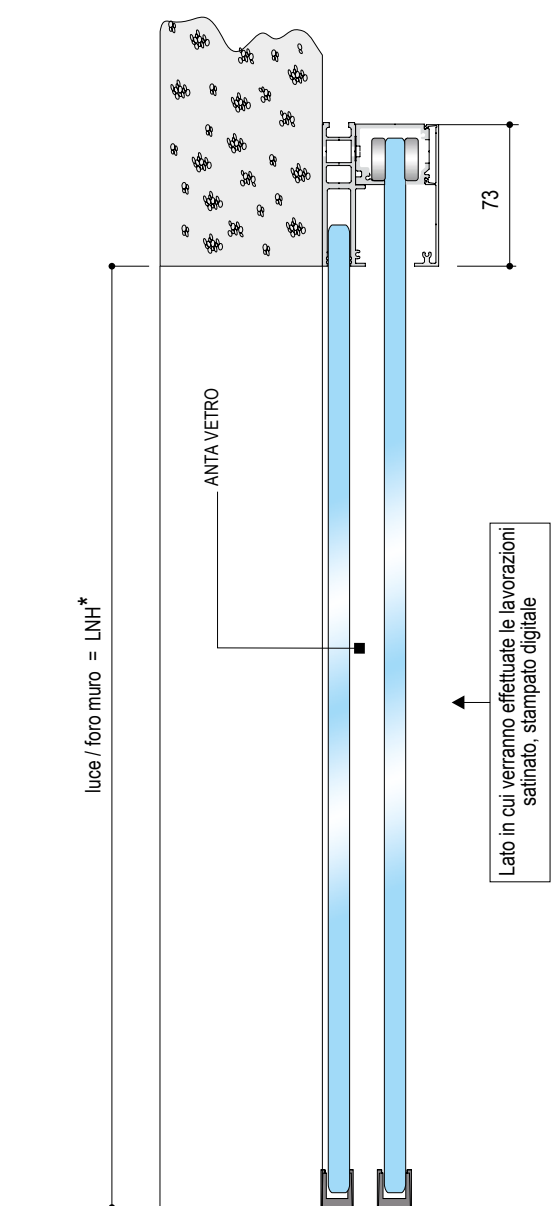
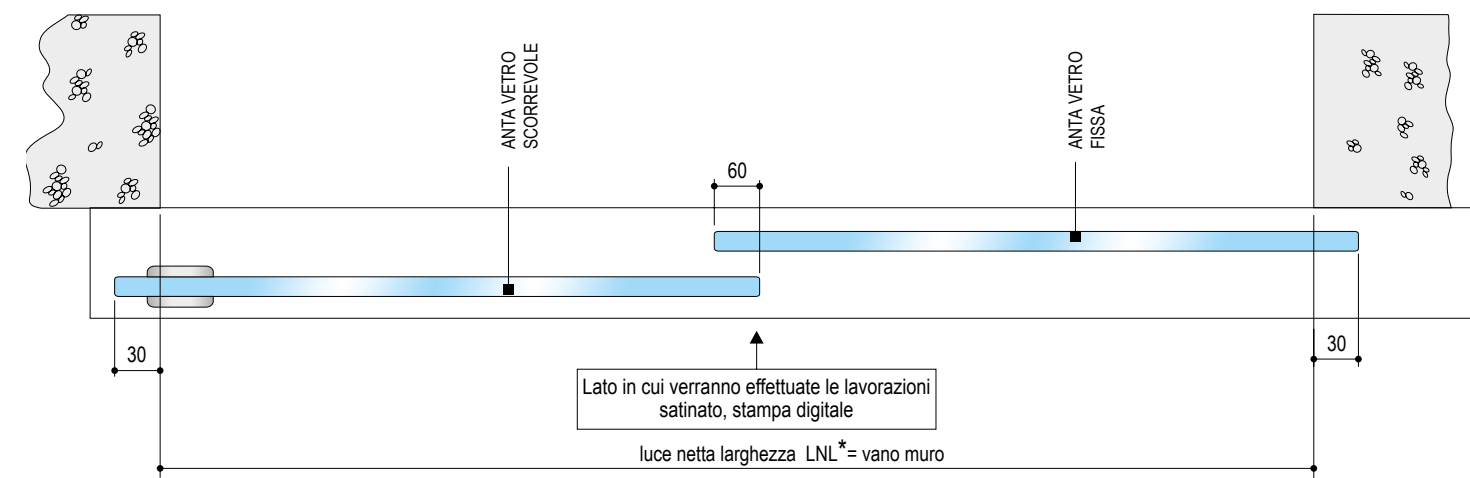

Tutti i riferimenti con l'asterisco (\*) sono da indicare nell'ordine

MANO D'APERTURA

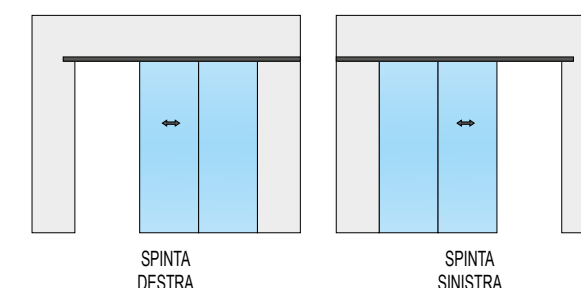



# GLD MATIQUE 66

APERTURA CON CERNIERE AUTOMATICHE AD UN'ANTA  
 SINGLE-LEAF OPENING WITH AUTOMATIC HINGES

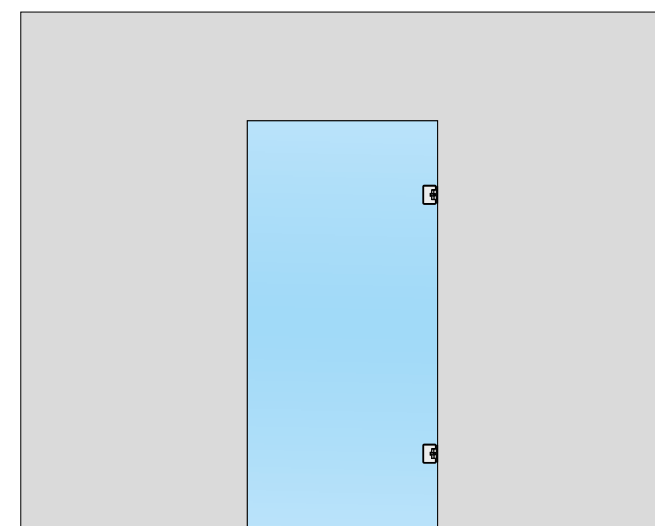
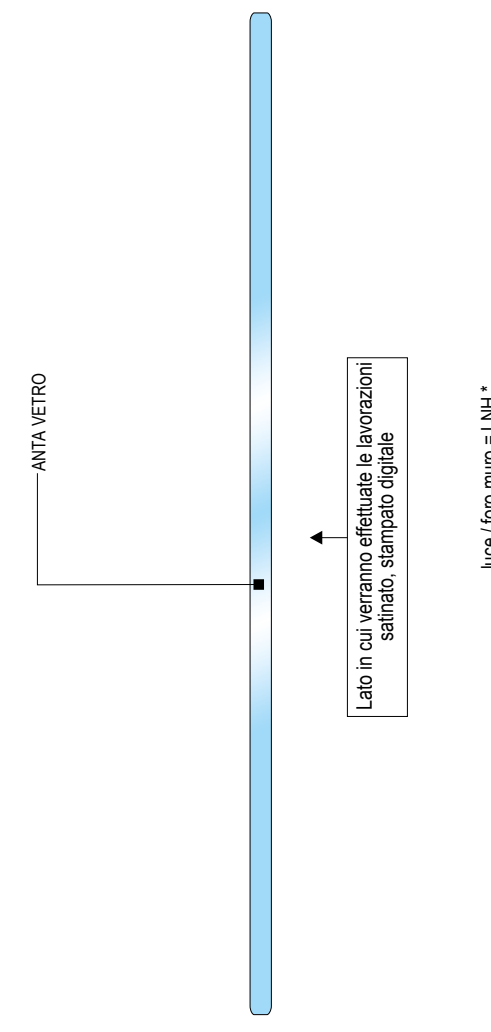
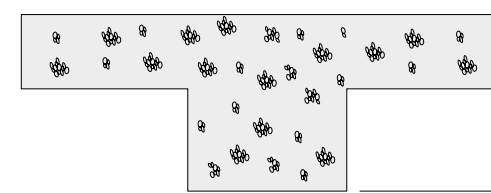
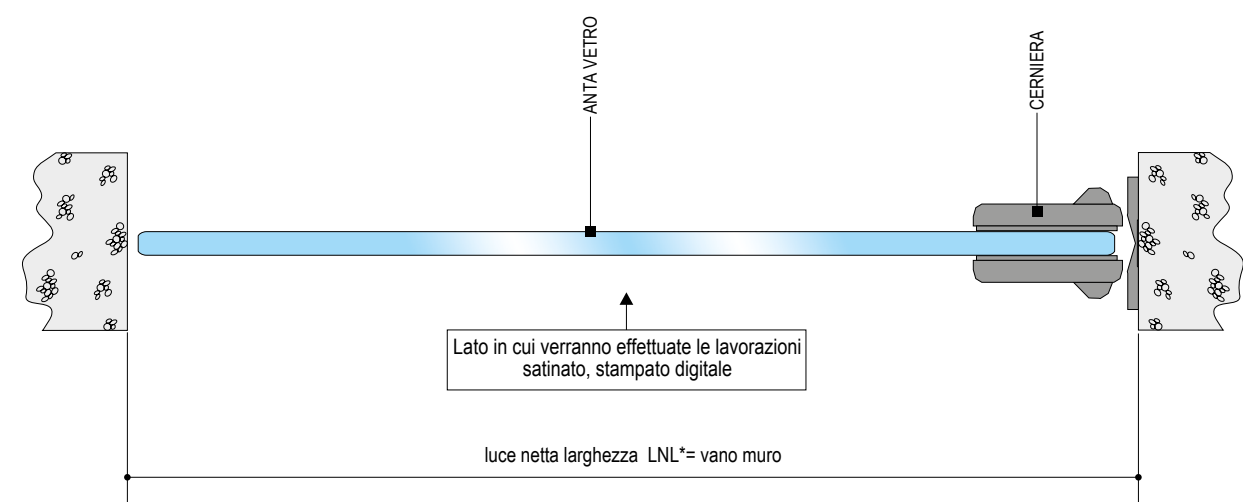

Tutti i riferimenti con l'asterisco (\*) sono da indicare nell'ordine

MANO D'APERTURA

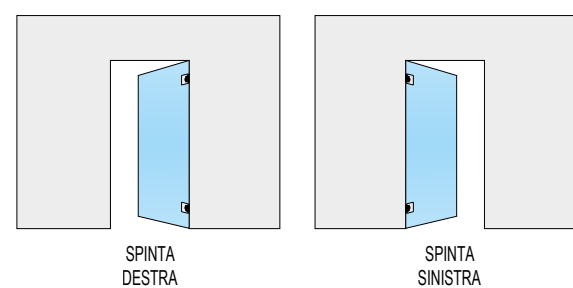

# GLD MATIQUE 66

APERTURA CON CERNIERE AUTOMATICHE DUE ANTE  
 DOUBLE-LEAF OPENING WITH AUTOMATIC HINGES

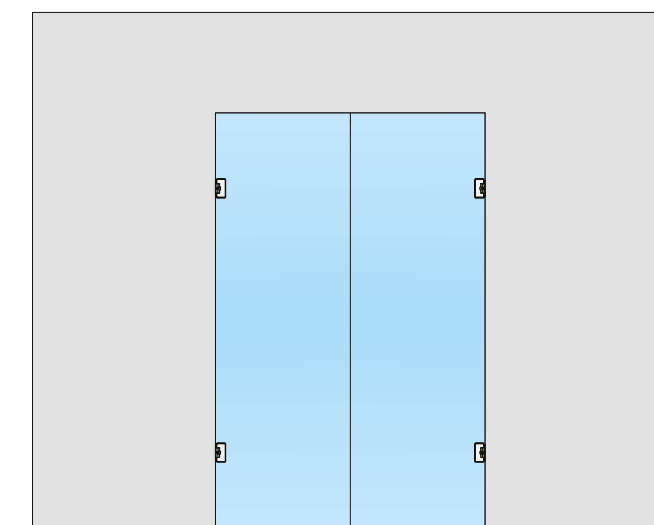
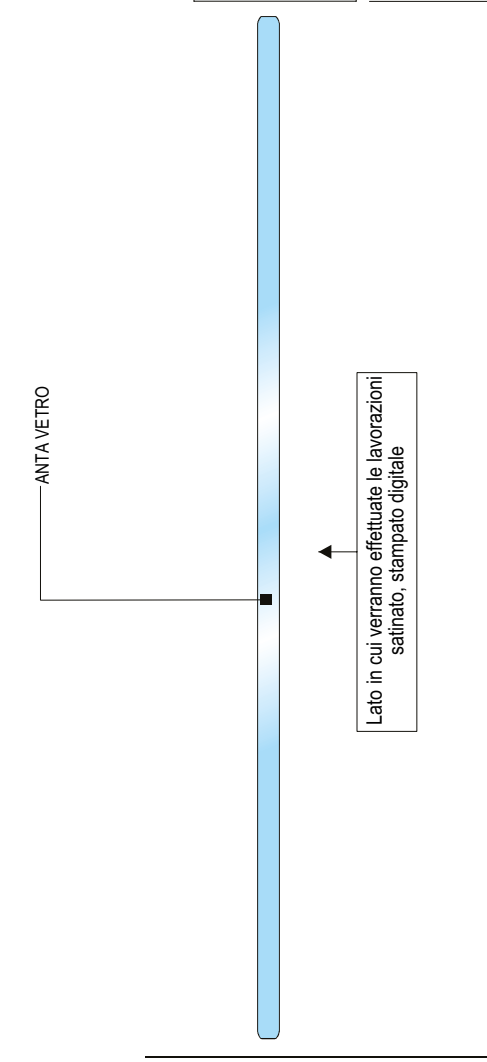
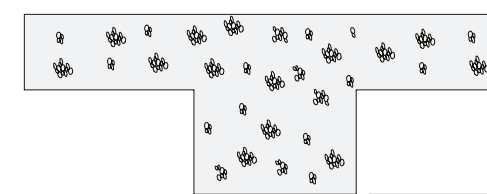
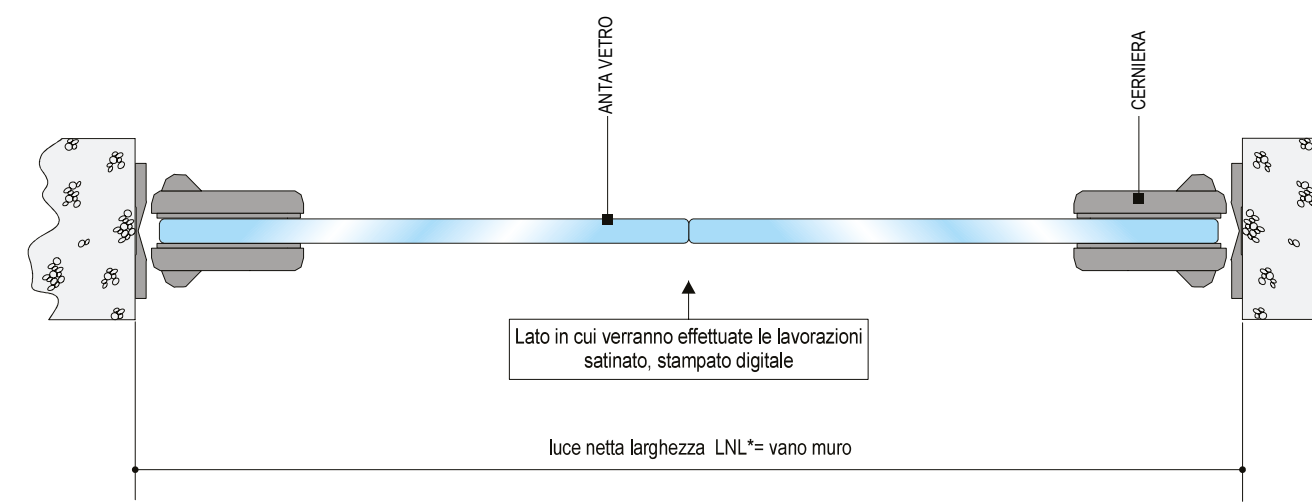

Tutti i riferimenti con l'asterisco (\*) sono da indicare nell'ordine

MANO D'APERTURA

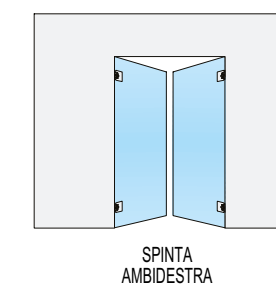



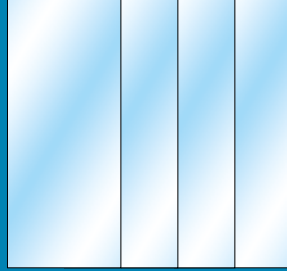

# GLD 482

PER PORTA DUE/TRE ANTE TRASCINATE + ANTA FISSA  
 FOR TWO/THREE SLIDED DOORS + FIXED LEAF

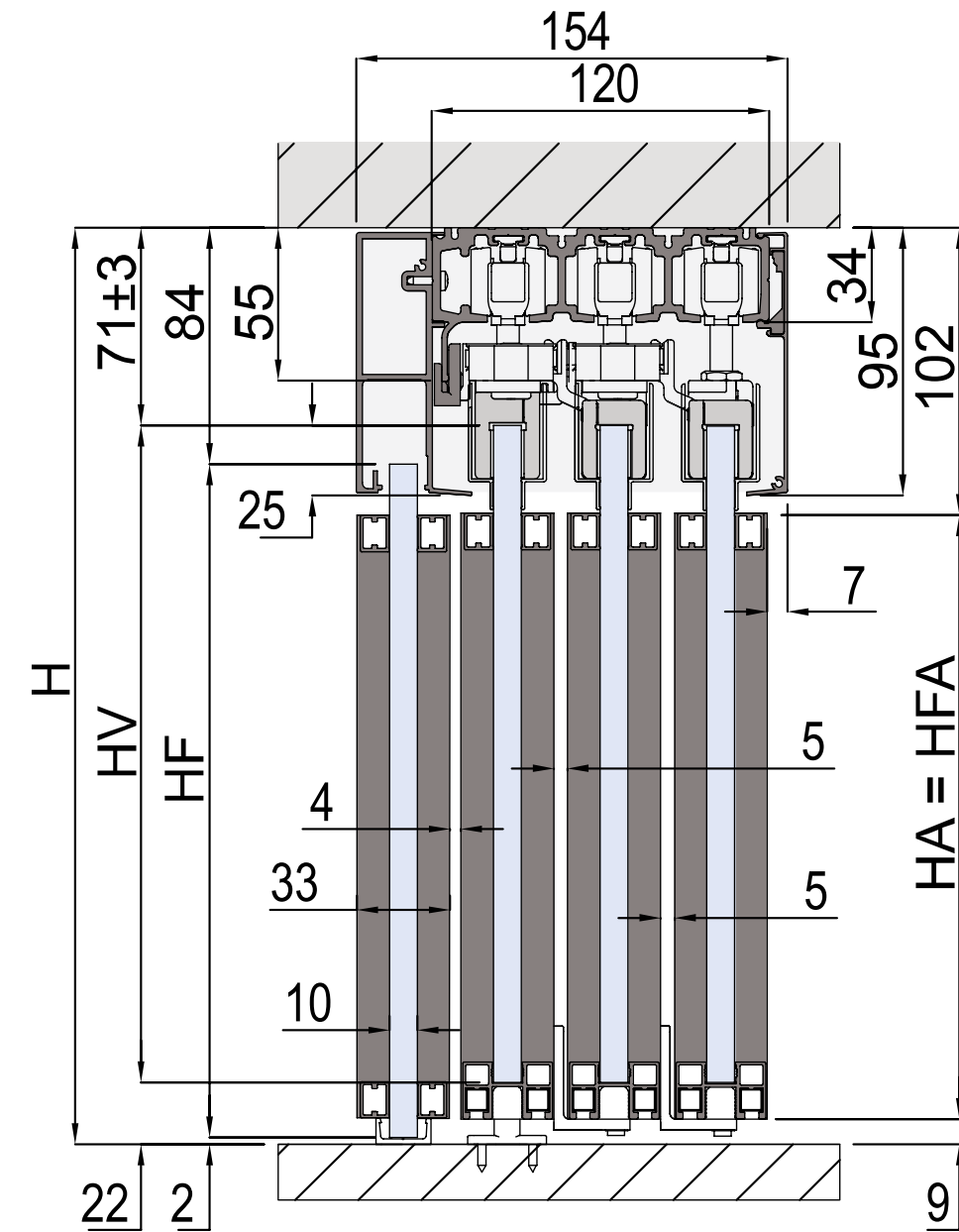

$$\begin{aligned}
 HV &= H - 93 \\
 HF &= H - 86 \\
 HA/HFA &= H - 111
 \end{aligned}$$

MANO D'APERTURA

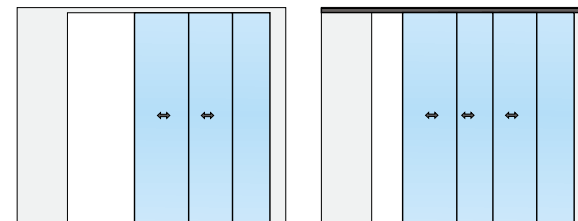

(solo ante simmetriche)  
 (symmetrical leaves only)

www.dierre.com  
 DIERRE SPA STRADA STATALE PER CHIERI 66/15 - 14019 VILLANOVA D'ASTI (AT)  
 TEL. +39 0141 949411 - E-MAIL: info@dierre.it

La carta scelta per questo prodotto è Carta Certificata FSC® per una gestione responsabile delle foreste e degli ecosistemi.

The paper chosen for this product is FSC® Certified Paper for responsible management of forests and ecosystems.



L'ambientazione ed il contesto estetico in cui le immagini delle porte sono state inserite sono puramente suggestivi e, pertanto, alcuni elementi presenti nelle foto (quali a titolo esemplificativo cornici, coprifili, accessori) potrebbero non essere disponibili o dover essere oggetto di specifica richiesta in sede di ordine.

The setting and aesthetic context the images of the doors have been inserted in are merely inspiring and, therefore, some items in the pictures (such as for example cornices, cover moulds, accessories) may not be available or be the subject of a specific request when ordering.

Le informazioni presenti in questo catalogo possono subire variazioni. I materiali rappresentati sono puramente indicativi; per la verifica dei colori si rimanda al campionario.

The information contained in this catalogue may undergo variations. The materials shown are a bare example; for the verification of colours please refer to the sample collection.



# LUCENTI

**Dierre**  
YOUR HOME, YOUR LIFE