

LUCENTI

**Dierre**
YOUR HOME, YOUR LIFE

LU CENTI

Dierre
YOUR HOME. YOUR LIFE



Oltre le apparenze

Quello che vediamo è frutto della nostra capacità di osservare e di immaginare.

Lì dove finisce lo sguardo inizia la fantasia. E in quel preciso istante prendono vita le emozioni che intessono la nostra esistenza come sottili trame di luce, giochi di contrasti, pieni e vuoti in cui cercare un equilibrio.

In questo intravedere, vedere attraverso, vedere oltre, alcuni desideri si concretizzano, divenendo materia luminosa che definisce lo spazio e lascia all'immaginazione la libertà di creare nuove emozioni.

Con la linea di porte per interni LUCENTI, Dierre cattura l'essenza di queste emozioni attraverso la luce, per trasformarla in nuovi spazi da vivere.

Beyond appearances

Everything we see is the result of our ability to observe and to imagine.

Where the gaze ends, imagination begins. That's when emotions come to life the emotions that thread our existence like subtle light weaves, contrasts, fullness and emptiness where a balance is sought.

Some desires materialise in this glimpse, see through, see beyond, becoming luminous matter that defines space and leaves freedom to the imagination in creating new emotions.

With the LUCENTI line of interior doors, Dierre capture the very essence of these emotions through light, to transform it into new living spaces.

LUCENTI Porte in vetro

LA MATERIA RACCONTA LA LUCE

Dierre cattura la trama narrativa della luce in questa nuova linea di porte a vetri, per raccontare lo spazio che prende vita.

ANTA VETRO STRATIFICATO TEMPERATO - Il vetro stratificato é composto da due lastre di vetro temperato assemblate su tutta la superficie mediante pellicola di PVB (Polivinilbutirrale), il vetro stratificato temperato offre una maggiore sicurezza perchè unisce la durezza del vetro temperato e l'elasticità della pellicola PVB. Questa tecnologia permette disegni / stampe / effetti di trasparenza all'interno della stratificazione.

ANTA VETRO TEMPERATO - La lastra in vetro subisce un trattamento termico di cottura che consiste nel riscaldamento del vetro fino alla temperatura di 700° per poi essere rapidamente raffreddato e riportato a temperatura ambientale. Con questo trattamento acquista le caratteristiche di resistenza cinque volte superiori agli shock termici e meccanici. In caso di rottura il vetro si rompe in migliaia di piccoli frammenti non taglienti.

IMBALLO - L'imballo per l'anta è eseguito in cassa in legno con protezioni. L'imballo per il telaio è costituito da involucro in cartone antiurto.

Urban

INDUSTRIAL DECOR	12
INDUSTRIAL CHIC DECOR	28
DEKÒ	36
MIRROR	38

Visual

NEUTRAL	50
FRAME	56
SETA	58
MARMO BLACK	60
MARMO WHITE	64
MARMO EMERALD	68

Natural

SPRING	78
VALERY	80
DANDELION	84
LEAF	88

Maniglie / Handles

93

Sistemi di apertura / Opening systems

102

INDICE



LUCENTI Glass doors

MATTER NARRATES LIGHT

With the narrative texture of light in this striking new line of glass doors, Diere captures the narrative of space coming to life.

TEMPERED LAMINATED GLASS LEAF - Laminated glass is composed of two tempered glass panes assembled over the entire surface by means of a PVB (polyvinyl butyral) film. Tempered laminated glass offers greater security because it combines the hardness of tempered glass and the elasticity of the PVB film. This technology allows designs / prints / transparency effects within the lamination.

TEMPERED GLASS LEAF - the glass sheet undergoes a thermal baking treatment that consists of heating the glass to a temperature of 700° and then quickly cooling it down to room temperature. This treatment makes it five times more resistant to thermal and mechanical shocks. In the event of breakage, the glass shatters into thousands of small, non-sharp fragments.

PACKAGING - The leaf is packed in a wooden crate with protections. Packaging for the frame is in shockproof cardboard box.

URBAN



INDUSTRIAL DECOR HORIZONTAL - BRONZO / BRONZE

Autentico contemporaneo
Authentically contemporary

Urban

INDUSTRIAL DECOR	12
INDUSTRIAL CHIC DECOR	28
DEKÒ	36
MIRROR	38
CORNICE PERIMETRALE	44





INDUSTRIAL DECOR
vetro trasparente extrachiaro
extra-clear transparent glass



INDUSTRIAL DECOR
vetro trasparente grigio
grey transparent glass



INDUSTRIAL DECOR
vetro trasparente bronzo
bronze transparent glass



Urban INDUSTRIAL DECOR

Il movimento delle linee orizzontali crea nuovo spazio e arreda, lasciando agli ambienti la loro intimità. Porta a vetro e listelli orizzontali decorativi, per fare luce e ombra allo stesso tempo.

Horizontal line movement creates new space and furnishes leaving the rooms their own intimacy. Glass door and horizontal decorative slats, to provide light and shade at the same time.

Descrizione: vetro trasparente extrachiaro con listelli orizzontali decorativi predisposto per perimetro in alluminio spessore 4+4 mm / *Description: extra-clear transparent glass with decorative horizontal strips prepared for 4+4 mm thick aluminium perimeter*

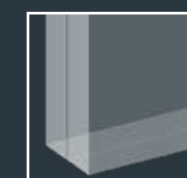

Vetro

Vetro trasparente extrachiaro
extra-clear transparent glass

Vetro trasparente grigio
grey transparent glass

Vetro trasparente bronzo
bronze transparent glass

Stampato digitale

Nero / *Black*

Bianco / *White*

Bronzo chiaro / *Light bronze*

Grigio / *Grey*



INDUSTRIAL DECOR
 vetro trasparente extrachiaro
extra-clear transparent glass



INDUSTRIAL DECOR
 vetro trasparente grigio
grey transparent glass



INDUSTRIAL DECOR
 vetro trasparente bronzo
bronze transparent glass



Urban INDUSTRIAL DECOR

Il movimento delle linee orizzontali crea nuovo spazio e arreda, lasciando agli ambienti la loro intimità. Porta a vetro e listelli orizzontali decorativi, per fare luce e ombra allo stesso tempo.

Horizontal line movement creates new space and furnishes leaving the rooms their own intimacy. Glass door and horizontal decorative slats, to provide light and shade at the same time.

Descrizione: vetro trasparente con listelli orizzontali decorativi predisposto per perimetro in alluminio spessore 4+4 mm / *Description: extra-clear transparent glass with decorative horizontal strips prepared for 4+4 mm thick aluminium perimeter*

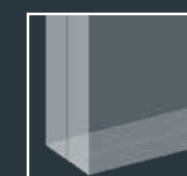

Vetro

Vetro trasparente extrachiaro
extra-clear transparent glass

Vetro trasparente grigio
grey transparent glass

Vetro trasparente bronzo
bronze transparent glass

Stampato digitale

Nero / *Black*

Bianco / *White*

Bronzo chiaro / *Light bronze*

Grigio / *Grey*



INDUSTRIAL DECOR
 vetro trasparente extrachiaro
extra-clear transparent glass



Urban INDUSTRIAL DECOR

Il movimento delle linee orizzontali crea nuovo spazio e arreda, lasciando agli ambienti la loro intimità. Porta a vetro e listelli orizzontali decorativi, per fare luce e ombra allo stesso tempo.

Horizontal line movement creates new space and furnishes leaving the rooms their own intimacy. Glass door and horizontal decorative slats, to provide light and shade at the same time.

INDUSTRIAL DECOR
 vetro trasparente grigio
grey transparent glass



INDUSTRIAL DECOR
 vetro trasparente bronzo
bronze transparent glass

Descrizione: vetro trasparente con listelli orizzontali decorativi predisposto per perimetro in alluminio spessore 4+4 mm / *Description: extra-clear transparent glass with decorative horizontal strips prepared for 4+4 mm thick aluminium perimeter*

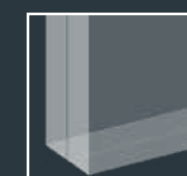

Vetro

Vetro trasparente extrachiaro
extra-clear transparent glass

Vetro trasparente grigio
grey transparent glass

Vetro trasparente bronzo
bronze transparent glass

Stampato digitale

Nero / *Black*

Bianco / *White*

Bronzo chiaro / *Light bronze*

Grigio / *Grey*



INDUSTRIAL DECOR
 vetro trasparente extrachiaro
extra-clear transparent glass



INDUSTRIAL DECOR
 vetro trasparente grigio
grey transparent glass



INDUSTRIAL DECOR
 vetro trasparente bronzo
bronze transparent glass



Urban INDUSTRIAL DECOR

Il movimento delle linee orizzontali crea nuovo spazio e arreda, lasciando agli ambienti la loro intimità. Porta a vetro e listelli orizzontali decorativi, per fare luce e ombra allo stesso tempo.

Horizontal line movement creates new space and furnishes leaving the rooms their own intimacy. Glass door and horizontal decorative slats, to provide light and shade at the same time.

Descrizione: vetro trasparente con listelli orizzontali decorativi predisposto per perimetro in alluminio spessore 4+4 mm / *Description: extra-clear transparent glass with decorative horizontal strips prepared for 4+4 mm thick aluminium perimeter*

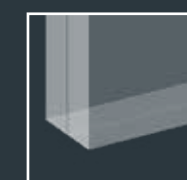

Vetro

Vetro trasparente extrachiaro
extra-clear transparent glass

Vetro trasparente grigio
grey transparent glass

Vetro trasparente bronzo
bronze transparent glass

Stampato digitale

Nero / *Black*

Bianco / *White*

Bronzo chiaro / *Light bronze*

Grigio / *Grey*



INDUSTRIAL DECOR
 vetro trasparente extrachiaro
extra-clear transparent glass



INDUSTRIAL DECOR
 vetro trasparente grigio
grey transparent glass



INDUSTRIAL DECOR
 vetro trasparente bronzo
bronze transparent glass



Urban INDUSTRIAL DECOR

Linee verticali, per un gioco di vedo-non-vedo che dà slancio a ogni ambiente.

Porta a vetro e listelli verticali con un effetto plissé molto contemporaneo.

Vertical lines, for a see-through effect that provides an added boost to any environment.

Glass door and vertical slats with a very contemporary pleated effect.

Descrizione: vetro trasparente con listelli verticali decorativi predisposto per perimetro in alluminio spessore 4+4 mm / *Description: clear glass with vertical decorative strips prepared for aluminium perimeter thickness 4+4 mm*

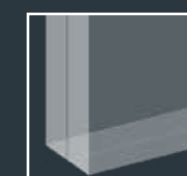

Vetro

Vetro trasparente extrachiaro
extra-clear transparent glass

Vetro trasparente grigio
grey transparent glass

Vetro trasparente bronzo
bronze transparent glass

Stampato digitale

Nero / *Black*

Bianco / *White*

Bronzo chiaro / *Light bronze*

Grigio / *Grey*



INDUSTRIAL DECOR
 vetro trasparente extrachiaro
extra-clear transparent glass



INDUSTRIAL DECOR
 vetro trasparente grigio
grey transparent glass



INDUSTRIAL DECOR
 vetro trasparente bronzo
bronze transparent glass



Urban INDUSTRIAL DECOR

Linee verticali, per un gioco di vedo-non-vedo che dà slancio a ogni ambiente.

Porta a vetro e listelli verticali con un effetto plissé molto contemporaneo.

Vertical lines, for a see-through effect that provides an added boost to any environment.

Glass door and vertical slats with a very contemporary pleated effect.

Descrizione: vetro trasparente con listelli verticali decorativi predisposto per perimetro in alluminio spessore 4+4 mm / *Description: clear glass with vertical decorative strips prepared for aluminium perimeter thickness 4+4 mm*

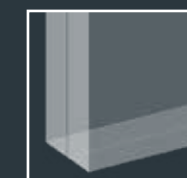

Vetro

Vetro trasparente extrachiaro
extra-clear transparent glass

Vetro trasparente grigio
grey transparent glass

Vetro trasparente bronzo
bronze transparent glass

Stampato digitale

Nero / *Black*

Bianco / *White*

Bronzo chiaro / *Light bronze*

Grigio / *Grey*



INDUSTRIAL DECOR
 vetro trasparente extrachiaro
extra-clear transparent glass



INDUSTRIAL DECOR
 vetro trasparente grigio
grey transparent glass



INDUSTRIAL DECOR
 vetro trasparente bronzo
bronze transparent glass

Urban INDUSTRIAL DECOR

Linee verticali, per un gioco di vedo-non-vedo che dà slancio a ogni ambiente.
 Porta a vetro e listelli verticali con un effetto plissé molto contemporaneo.

*Vertical lines, for a see-through effect that provides an added boost to any environment.
 Glass door and vertical slats with a very contemporary pleated effect.*

Descrizione: vetro trasparente con listelli verticali decorativi predisposto per perimetro in alluminio spessore 4+4 mm / *Description: clear glass with vertical decorative strips prepared for aluminium perimeter thickness 4+4 mm*

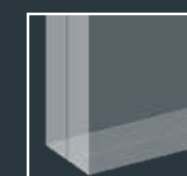

Vetro

Vetro trasparente extrachiaro
extra-clear transparent glass

Vetro trasparente grigio
grey transparent glass

Vetro trasparente bronzo
bronze transparent glass

Stampato digitale

Nero / *Black*

Bianco / *White*

Bronzo chiaro / *Light bronze*

Grigio / *Grey*



INDUSTRIAL DECOR
 vetro trasparente extrachiaro
extra-clear transparent glass



INDUSTRIAL DECOR
 vetro trasparente grigio
grey transparent glass



INDUSTRIAL DECOR
 vetro trasparente bronzo
bronze transparent glass



Urban INDUSTRIAL DECOR

Linee verticali, per un gioco di vedo-non-vedo che dà slancio a ogni ambiente.
 Porta a vetro e listelli verticali con un effetto plissé molto contemporaneo.

*Vertical lines, for a see-through effect that provides an added boost to any environment.
 Glass door and vertical slats with a very contemporary pleated effect.*

Descrizione: vetro trasparente con listelli verticali decorativi predisposto per perimetro in alluminio spessore 4+4 mm / *Description: clear glass with vertical decorative strips prepared for aluminium perimeter thickness 4+4 mm*

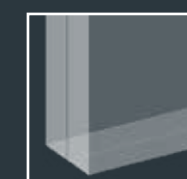

Vetro

Vetro trasparente extrachiaro
extra-clear transparent glass

Vetro trasparente grigio
grey transparent glass

Vetro trasparente bronzo
bronze transparent glass

Stampato digitale

Nero / *Black*

Bianco / *White*

Bronzo chiaro / *Light bronze*

Grigio / *Grey*



INDUSTRIAL CHIC DECOR
vetro trasparente extrachiaro
extra-clear transparent glass



INDUSTRIAL CHIC DECOR
vetro trasparente grigio
grey transparent glass



INDUSTRIAL CHIC DECOR
vetro trasparente bronzo
bronze transparent glass



Urban INDUSTRIAL CHIC DECOR

Geometrie e proporzioni definiscono lo spazio, regalando armonia e personalità.
Porta a vetro caratterizzata da un raffinato disegno a quadri.

*Shapes and proportions define the space, bringing harmony and personality.
Glass door featuring a refined checked pattern.*

Descrizione: vetro trasparente con listelli inglesina decorativi predisposto per perimetro in alluminio spessore 4+4 mm / *Descrizione: vetro trasparente con listelli stampati che disegnano riquadri predisposto per perimetro*

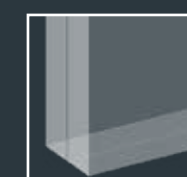

Vetro

Vetro trasparente extrachiaro
extra-clear transparent glass

Vetro trasparente grigio
grey transparent glass

Vetro trasparente bronzo
bronze transparent glass

Stampato digitale

Nero / *Black*

Bianco / *White*

Bronzo chiaro / *Light bronze*

Grigio / *Grey*



INDUSTRIAL CHIC DECOR
 vetro trasparente extrachiaro
extra-clear transparent glass



INDUSTRIAL CHIC DECOR
 vetro trasparente grigio
grey transparent glass



INDUSTRIAL CHIC DECOR
 vetro trasparente bronzo
bronze transparent glass



Urban INDUSTRIAL CHIC DECOR

Geometrie e proporzioni definiscono lo spazio, regalando armonia e personalità.
 Porta a vetro caratterizzata da un raffinato disegno a quadri.

*Geometrie e proporzioni definiscono lo spazio, regalando armonia e personalità.
 Porta a vetro caratterizzata da un raffinato disegno a quadri.*

Descrizione: vetro trasparente con listelli inglesina decorativi predisposto per perimetro in alluminio spessore 4+4 mm / *Descrizione: vetro trasparente con listelli stampati che disegnano riquadri predisposto per perimetro*

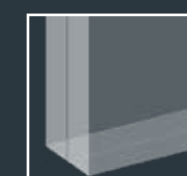

Vetro

Vetro trasparente extrachiaro
extra-clear transparent glass

Vetro trasparente grigio
grey transparent glass

Vetro trasparente bronzo
bronze transparent glass

Stampato digitale

Nero / *Black*

Bianco / *White*

Bronzo chiaro / *Light bronze*

Grigio / *Grey*



INDUSTRIAL CHIC DECOR
vetro trasparente extrachiaro
extra-clear transparent glass



INDUSTRIAL CHIC DECOR
vetro trasparente grigio
grey transparent glass



INDUSTRIAL CHIC DECOR
vetro trasparente bronzo
bronze transparent glass



Urban INDUSTRIAL CHIC DECOR

Geometrie e proporzioni definiscono lo spazio, regalando armonia e personalità.
Porta a vetro caratterizzata da un raffinato disegno a quadri.

*Geometrie e proporzioni definiscono lo spazio, regalando armonia e personalità.
Porta a vetro caratterizzata da un raffinato disegno a quadri.*

Descrizione: vetro trasparente con listelli inglesina decorativi predisposto per perimetro in alluminio spessore 4+4 mm / *Descrizione: vetro trasparente con listelli stampati che disegnano riquadri predisposto per perimetro*

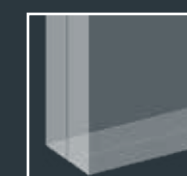

Vetro

Vetro trasparente extrachiaro
extra-clear transparent glass

Vetro trasparente grigio
grey transparent glass

Vetro trasparente bronzo
bronze transparent glass

Stampato digitale

Nero / *Black*

Bianco / *White*

Bronzo chiaro / *Light bronze*

Grigio / *Grey*



INDUSTRIAL CHIC DECOR
 vetro trasparente extrachiaro
extra-clear transparent glass



INDUSTRIAL CHIC DECOR
 vetro trasparente grigio
grey transparent glass



INDUSTRIAL CHIC DECOR
 vetro trasparente bronzo
bronze transparent glass



Urban INDUSTRIAL CHIC DECOR

Geometrie e proporzioni definiscono lo spazio, regalando armonia e personalità.
 Porta a vetro caratterizzata da un raffinato disegno a quadri.

*Geometrie e proporzioni definiscono lo spazio, regalando armonia e personalità.
 Porta a vetro caratterizzata da un raffinato disegno a quadri.*

Descrizione: vetro trasparente con listelli inglesina decorativi predisposto per perimetro in alluminio spessore 4+4 mm / *Descrizione: vetro trasparente con listelli stampati che disegnano riquadri predisposto per perimetro*

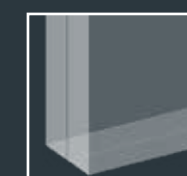

Vetro

Vetro trasparente extrachiaro
extra-clear transparent glass

Vetro trasparente grigio
grey transparent glass

Vetro trasparente bronzo
bronze transparent glass

Stampato digitale

Nero / *Black*

Bianco / *White*

Bronzo chiaro / *Light bronze*

Grigio / *Grey*

Urban DEKÒ

Un pattern ritmico a linee morbide decora con semplicità il vetro dalle tinte neutre. Porta a vetro decorata, sofisticata in ogni ambiente.

Soft-line rhythmic patterning simply decorates the glass in neutral colours. Decorated glass door, refined in any environment.

Descrizione: vetro trasparente stampato digitale con disegno Dekò spessore 10 mm / *Description: digitally printed clear glass with Dekò design 10 mm thick*

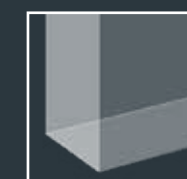

Vetro

Vetro trasparente bronzo
bronze transparent glass

Vetro trasparente grigio
grey transparent glass



DEKÒ
vetro trasparente bronzo
bronze transparent glass



DEKÒ
vetro trasparente grigio
grey transparent glass

Urban MIRROR

Amplifica lo spazio, attira la luce, riflette la bellezza.

Porta con anta a specchio dalle linee leggere. Ideale per camere da letto con cabine armadio o per arredare spazi piccoli.

Amplifies space, attracts light, reflects beauty.

Mirror door with light lines.

Ideal for bedrooms with walk-in wardrobes or for furnishing small spaces.



MIRROR
specchio classic
classic mirror

Descrizione: specchio classic predisposto per perimetro in alluminio spessore 4+4 mm / *Description: classic mirror prepared for aluminium perimeter 4+4 mm thick*

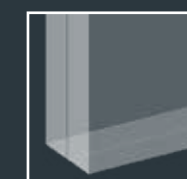

Vetro

Specchio classic
Classic mirror

Perimetro intelaiato colori pag 44
Framed perimeter colours page 44

Urban MIRROR

Amplifica lo spazio, attira la luce, riflette la bellezza.

Porta con anta a specchio dalle linee leggere. Ideale per camere da letto con cabine armadio o per arredare spazi piccoli.

Amplifies space, attracts light, reflects beauty.

Mirror door with light lines.

Ideal for bedrooms with walk-in wardrobes or for furnishing small spaces.



MIRROR
specchio fumè
smoked mirror

Descrizione: specchio fumé predisposto per perimetro in alluminio spessore 4+4 mm / Description: smoked mirror prepared for aluminium perimeter 4+4 mm thick

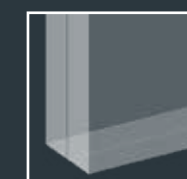

Vetro

Specchio fumé
Smoked mirror

Perimetro intelaiato colori pag 44
Framed perimeter colours page 44

Urban

INDUSTRIAL DECOR ORIZZONTALE



Nero / Black



Bianco / White



Bronzo / Bronze



Grigio / Grey

DEKO'



INDUSTRIAL DECOR VERTICALE

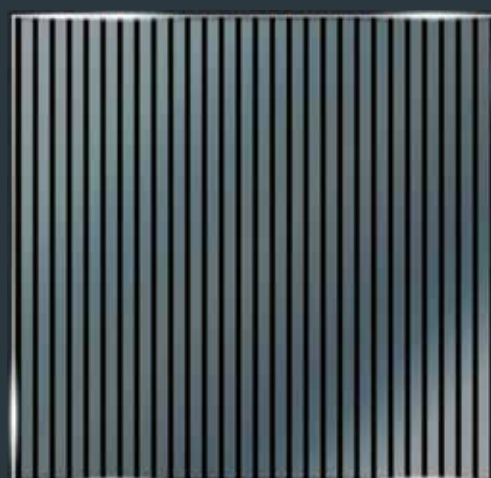

Nero / Black



Bianco / White



Bronzo / Bronze



Grigio / Grey

MIRROR



Specchio classic

MIRROR



Specchio fumé

INDUSTRIAL CHIC DECOR



Nero / Black



Bianco / White



Bronzo / Bronze



Grigio / Grey

CORNICE PERIMETRALE



CORNICE PERIMETRALE

Modello Industrial e Mirror predisposti per perimetro in alluminio.
Spessore 4 + 4 mm

PERIMETER CORNICE

*Industrial and Mirror models prepared for aluminium perimeter.
Thickness 4 + 4 mm*

Finitura

Grigio
Grey
Bronzo chiaro
Light bronze
Bianco opaco
Matt white
Nero opaco
Matte black

Modelli

Industrial decor horizontal
Industrial decor vertical
Industrial chic decor
Mirror

VISUAL

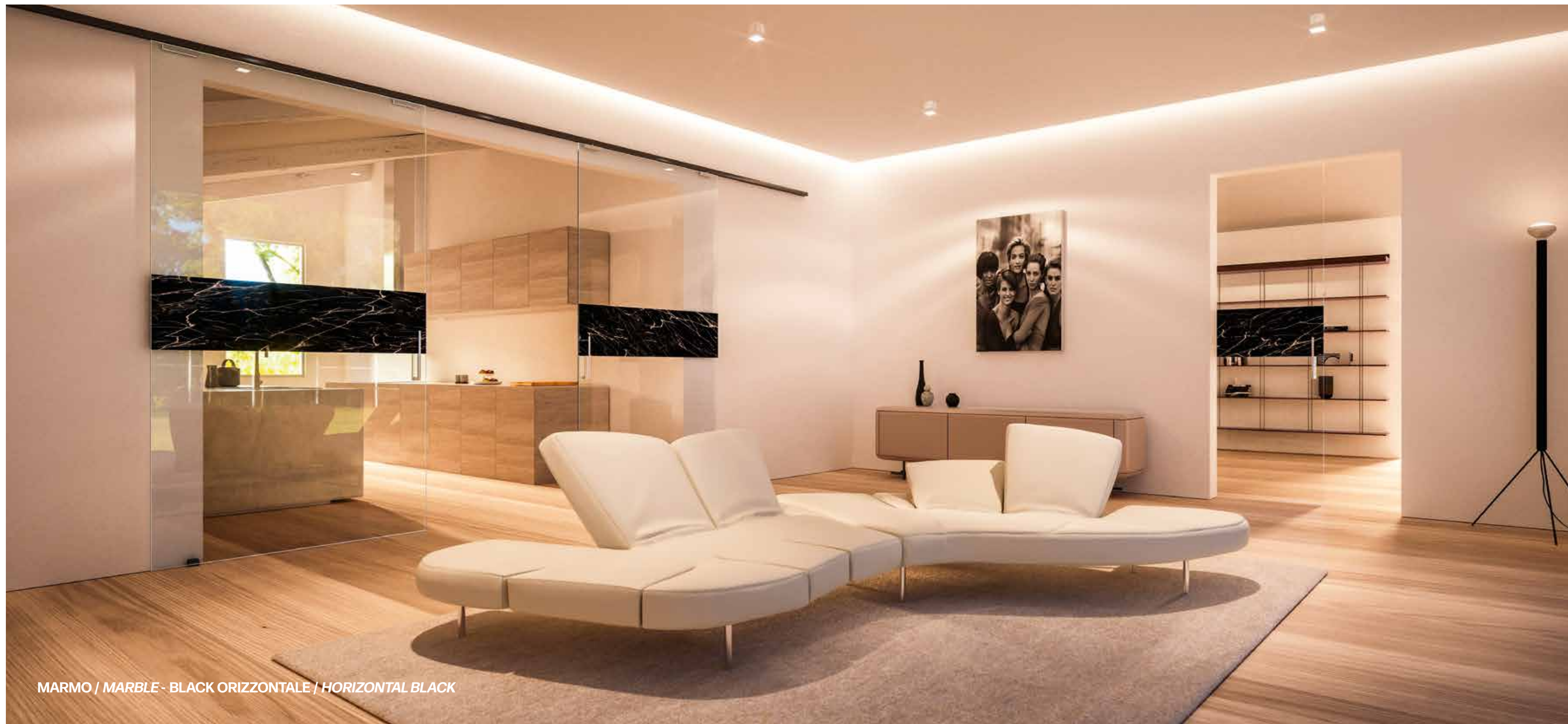

MARMO / MARBLE - BLACK ORIZZONTALE / HORIZONTAL BLACK

Dettagli di stile
Stylish details

Visual

NEUTRAL	50
FRAME	56
SETA	58
MARMO BLACK	60
MARMO WHITE	64
MARMO EMERALD	68



Visual NEUTRAL

La luce nella sua forma piü pura.
Essenziale, elegante, rivelatrice.
Porta trasparente che separa
gli ambienti conservando continuitä.
Arreda con discrezione,
si lascia ammirare quando serve.

*Light in its purest form.
Essential, elegant, revealing.
See-through door separating
environments while preserving continuity.
Furnishes discretely, it can be admired
when needed.*

Descrizione: vetro satinato chiaro spessore 8 mm / Description: clear satin glass thickness 8 mm



Vetro

Vetro satinato chiaro
Clear satin glass



NEUTRAL
vetro satinato chiaro
clear satin glass

Visual NEUTRAL

La luce nella sua forma piü pura.
Essenziale, elegante, rivelatrice.
Porta trasparente che separa
gli ambienti conservando continuitä.
Arreda con discrezione,
si lascia ammirare quando serve.

*Light in its purest form.
Essential, elegant, revealing.
See-through door separating
environments while preserving continuity.
Furnishes discretely, it can be admired
when needed.*

Descrizione: vetro trasparente extrachiaro
spessore 8 mm / *Description: extra-clear
transparent glass thickness 8 mm*

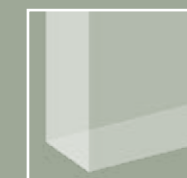

Vetro

Vetro trasparente extrachiaro
Extra-clear transparent glass



NEUTRAL
vetro trasparente extrachiaro
extra-clear transparent glass

Visual NEUTRAL

La luce nella sua forma piü pura.
Essenziale, elegante, rivelatrice.
Porta trasparente che separa
gli ambienti conservando continuità.
Arreda con discrezione,
si lascia ammirare quando serve.

*Light in its purest form.
Essential, elegant, revealing.
See-through door separating
environments while preserving continuity.
Furnishes discretely, it can be admired
when needed.*

Descrizione: vetro trasparente grigio spessore
8 mm / Description: grey transparent glass
thickness 8 mm

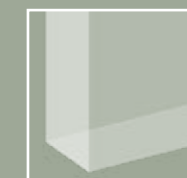

Vetro

Vetro trasparente grigio
Grey transparent glass



NEUTRAL
vetro trasparente grigio
grey transparent glass



FRAME
vetro trasparente extrachiaro
extra-clear transparent glass



FRAME
vetro satinato chiaro
clear satin glass

Visual FRAME

La forma dell'eleganza è una geometria di trasparenze che esprime la personalità di ogni ambiente.
 Porta a vetro con decorazioni geometriche nei toni nero, grigio e bianco.

*An elegant shape is a geometry of transparencies that expresses the personality of each environment.
 Glass door with geometric decorations in black, grey and white.*

Descrizione: vetro stampato digitale spessore 5 + 5 mm - 10 mm / *Description: digitally printed glass thickness 5 + 5 mm - 10 mm*

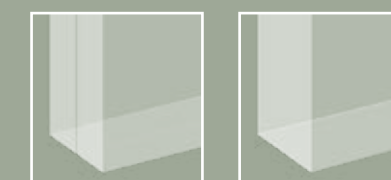

Vetro

Vetro trasparente extrachiaro
Extra-clear transparent glass

Vetro satinato chiaro
Clear satin glass

Stampato digitale

Decoro geometrico / *Geometric decoration*

Visual SETA

Immergersi nella bellezza di onde di luce che ricordano l'armonia della natura.

Porta a vetro con sottili decorazioni stampate in digitale.

Dipping into the beauty of waves of light reminiscent of the harmony of nature.

Glass door with digitally printed fine decors.

Descrizione: vetro satinato chiaro stampato digitale con disegno seta spessore 10 mm /
Description: clear digitally printed satin glass with silk design thickness 10 mm



Vetro

Vetro satinato chiaro
Clear satin glass

Stampato digitale

Grey / Grey
Ocra / Ocher



SETA Grey
vetro satinato chiaro
clear satin glass



SETA Ocra
vetro satinato chiaro
clear satin glass





MARMO
 vetro trasparente extrachiaro
 extra-clear transparent glass

Visual MARMO Black

Il prestigio della materia, la forza dei contrasti tra la trasparenza del vetro e il fascino del marmo. Porta a vetro con inserto in marmo. Il classico interpretato in chiave contemporanea.

The prestige of substance, the strength of contrasts between the transparency of glass and the charm of marble. Glass door with marble insert. Classic interpreted in a contemporary contemporary.

Descrizione: vetro trasparente extrachiaro stampato digitale con disegno verticale marmo black spessore 5+5 mm / *Description: extra-clear transparent glass digitally printed with vertical black marble pattern 5+5 mm thick*

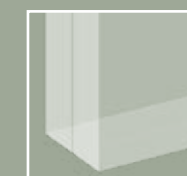

Vetro

Vetro trasparente extrachiaro
 Extra-clear transparent glass

Stampato digitale

Verticale marmo black / *Vertical black marble*
 Orizzontale marmo black / *Horizontal black marble*



MARMO
 vetro trasparente extrachiaro
 extra-clear transparent glass



Visual MARMO Black

Il prestigio della materia, la forza dei contrasti tra la trasparenza del vetro e il fascino del marmo. Porta a vetro con inserto in marmo. Il classico interpretato in chiave contemporanea.

The prestige of substance, the strength of contrasts between the transparency of glass and the charm of marble. Glass door with marble insert. Classic interpreted in a contemporary contemporary.

Descrizione: vetro trasparente extrachiaro stampato digitale con disegno orizzontale marmo black spessore 5+5 mm / *Description: extra-clear transparent glass digitally printed with horizontal black marble pattern 5+5 mm thick*

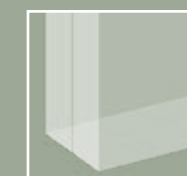

Vetro

Vetro trasparente extrachiaro
 Extra-clear transparent glass

Stampato digitale

Verticale marmo black / *Vertical black marble*
 Orizzontale marmo black / *Horizontal black marble*



MARMO
 vetro trasparente extrachiaro
 extra-clear transparent glass

Visual MARMO White

Il prestigio della materia, la forza dei contrasti tra la trasparenza del vetro e il fascino del marmo. Porta a vetro con inserto in marmo. Il classico interpretato in chiave contemporanea.

The prestige of substance, the strength of contrasts between the transparency of glass and the charm of marble. Glass door with marble insert. Classic interpreted in a contemporary contemporary.

Descrizione: vetro trasparente extrachiaro stampato digitale con disegno verticale marmo white spessore 5+5 mm / *Description: extra-clear transparent glass digitally printed with vertical white marble pattern 5+5 mm thick*

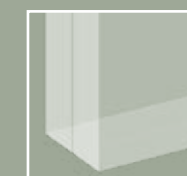

Vetro

Vetro trasparente extrachiaro
 Extra-clear transparent glass

Stampato digitale

Verticale marmo white / *Vertical white marble*
 Orizzontale marmo white / *Horizontal white marble*

Visual MARMO White

Il prestigio della materia, la forza dei contrasti tra la trasparenza del vetro e il fascino del marmo. Porta a vetro con inserto in marmo. Il classico interpretato in chiave contemporanea.

The prestige of substance, the strength of contrasts between the transparency of glass and the charm of marble. Glass door with marble insert. Classic interpreted in a contemporary contemporary.

Descrizione: vetro trasparente extrachiaro stampato digitale con disegno orizzontale marmo white spessore 5+5 mm / *Description: extra-clear transparent glass digitally printed with horizontal white marble pattern 5+5 mm thick*

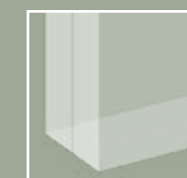

Vetro

Vetro trasparente extrachiaro
Extra-clear transparent glass

Stampato digitale

Verticale marmo white / Vertical white marble
Orizzontale marmo white / Horizontal white marble



MARMO
vetro trasparente extrachiaro
extra-clear transparent glass





MARMO
 vetro trasparente extrachiaro
 extra-clear transparent glass

Visual MARMO Emerald

Il prestigio della materia, la forza dei contrasti tra la trasparenza del vetro e il fascino del marmo. Porta a vetro con inserto in marmo. Il classico interpretato in chiave contemporanea.

The prestige of substance, the strength of contrasts between the transparency of glass and the charm of marble. Glass door with marble insert. Classic interpreted in a contemporary contemporary.

Descrizione: vetro trasparente extrachiaro stampato digitale con disegno verticale marmo emerald spessore 5+5 mm / *Description: extra-clear transparent glass digitally printed with vertical emerald marble pattern 5+5 mm thick*

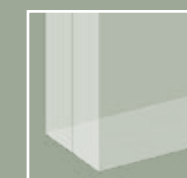

Vetro

Vetro trasparente extrachiaro
 Extra-clear transparent glass

Stampato digitale

Verticale marmo emerald / *Vertical emerald marble*
 Orizzontale marmo emerald / *Horizontal emerald marble*



MARMO
 vetro trasparente extrachiaro
 extra-clear transparent glass



Visual MARMO Emerald

Il prestigio della materia, la forza dei contrasti tra la trasparenza del vetro e il fascino del marmo. Porta a vetro con inserto in marmo. Il classico interpretato in chiave contemporanea.

The prestige of substance, the strength of contrasts between the transparency of glass and the charm of marble. Glass door with marble insert. Classic interpreted in a contemporary contemporary.

Descrizione: vetro trasparente extrachiaro stampato digitale con disegno orizzontale marmo emerald spessore 5+5 mm / *Description: extra-clear transparent glass digitally printed with horizontal emerald marble pattern 5+5 mm thick*

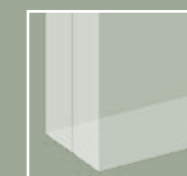

Vetro

Vetro trasparente extrachiaro
 Extra-clear transparent glass

Stampato digitale

Verticale marmo emerald / *Vertical emerald marble*
 Orizzontale marmo emerald / *Horizontal emerald marble*

Visual

NEUTRAL



Vetro satinato chiaro /
Clear satin glass



Vetro trasparente extrachiaro /
Extra-clear transparent glass



Vetro trasparente grigio /
Transparent gray glass

MARMO / MARBLE



Black verticale /
vertical Black



Black orizzontale /
horizontal Black

FRAME



Decoro geometrico /
Geometric pattern



Ocra / Ocher



Grey

MARMO / MARBLE



White verticale /
White vertical



White orizzontale /
White horizontal

MARMO / MARBLE



Emerald verticale /
Vertical Emerald



Emerald orizzontale /
Horizontal Emerald

NATURAL



SPRING - DECORO NATURA / NATURE DECORATION

Spazio alla natura
Open to nature

Natural

SPRING	78
VALERY	80
DANDELION	84
LEAF	88





SPRING
vetro trasparente extrachiaro
extra-clear transparent glass



SPRING
vetro satinato chiaro
clear satin glass

Natural SPRING

L'essenza della primavera entra in ogni ambiente e porta freschezza e leggerezza con decori delicati. Porta a vetro con decorazione a colori, per una casa dai toni caldi e naturali e per chi cerca la tranquillità della natura.

Spring scents enter into every room bringing freshness and lightness with delicate decors.

Glass door with coloured pattern, for a home with warm, natural tones and for those seeking the peacefulness of nature.

Descrizione: vetro stampato digitale con disegno spring spessore 5+5 mm - 10 mm / *Description: digitally printed glass with spring pattern thickness 5+5 mm - 10 mm*



Vetro

Vetro trasparente extrachiaro
Extra-clear transparent glass

Vetro satinato chiaro
Clear satin glass

Stampato digitale Digitally printed

Decoro natura / *Nature pattern*

Natural VALERY Ocra

Tra luce e ombra prende vita l'eleganza, delineata dalla silhouette di grandi ninfee. Porta a vetro con decorazione digitale, dai toni caldi dell'ocra o del grigio chiaro.

Between light and shadow, elegance comes to life, outlined by the contours of large water lilies. Glass door with digital decoration, in warm tones of ochre or light grey.

VALERY
vetro satinato grigio
grey satin glass

Descrizione: vetro stampato digitale con disegno Valery spessore 10 mm / *Description: digitally printed glass with Valery pattern thickness 10 mm*

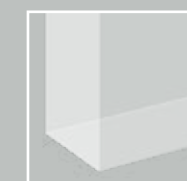

Vetro

Satinato grigio
Satin grey

Stampato digitale *Digitally printed*

Ocra / *Ocher*

Bianco / *White*



Natural VALERY Grigio chiaro

Tra luce e ombra prende vita l'eleganza, delineata dalla silhouette di grandi ninfee. Porta a vetro con decorazione digitale, dai toni caldi dell'ocra o del grigio chiaro.

Between light and shadow, elegance comes to life, outlined by the contours of large water lilies. Glass door with digital decoration, in warm tones of ochre or light grey.

Descrizione: vetro stampato digitale con disegno Valery spessore 10 mm / *Description: digitally printed glass with Valery pattern thickness 10 mm*

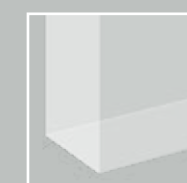

Vetro

Satinato grigio
Satin grey

Stampato digitale Digitally printed

Ocra / Ocher
Bianco / White



VALERY
vetro satinato grigio
grey satin glass



DANDELION
vetro trasparente extrachiaro
extra-clear transparent glass



DANDELION
vetro satinato chiaro
clear satin glass



Natural **DANDELION White**

Simbolo di leggerezza e delicatezza per eccellenza, il soffione porta il suo incanto e la sua finezza in ogni ambiente. Porta a vetro con decorazione digitale in bianco o nero.

Lightness and delicacy par excellence, the dandelion brings its enchantment and finesse into any environment. Glass door with digital decoration in white or black.

Descrizione: vetro stampato digitale con disegno Dandelion spessore 5 + 5 mm - 10 mm /
 Description: digitally printed glass with Dandelion pattern thickness 5+5 mm - 10 mm



Vetro

Vetro trasparente extrachiaro
Extra-clear transparent glass

Vetro satinato chiaro
Clear satin glass

Stampato digitale
Digitally printed

Bianco / White

Nero / Black



DANDELION
vetro trasparente extrachiaro
extra-clear transparent glass



DANDELION
vetro satinato chiaro
clear satin glass

Natural **DANDELION Black**

Simbolo di leggerezza e delicatezza per eccellenza, il soffione porta il suo incanto e la sua finezza in ogni ambiente. Porta a vetro con decorazione digitale in bianco o nero.

Lightness and delicacy par excellence, the dandelion brings its enchantment and finesse into any environment. Glass door with digital decoration in white or black.

Descrizione: vetro stampato digitale con disegno Dandelion spessore 5 + 5 mm - 10 mm /
 Description: digitally printed glass with Dandelion pattern thickness 5+5 mm - 10 mm



Vetro

Vetro trasparente extrachiaro
Extra-clear transparent glass

Vetro satinato chiaro
Clear satin glass

Stampato digitale *Digitally printed*

Bianco / *White*

Nero / *Black*



LEAF
vetro trasparente grigio
vetro trasparente grigio



LEAF
vetro satinato grigio
grey satin glass

Natural LEAF

Un lieve accenno alla natura, come un soffice letto di foglie mosso dal vento. Per riscoprire il piacere della leggerezza. Porta a vetro con decorazione digitale tono su tono a tema natura.

A faint hint of nature, resembling a soft bed of leaves tossed by the wind. Towards the pleasure of rediscovering lightness. Glass door with tone on tone digital decoration with a nature theme.

Descrizione: vetro stampato digitale con disegno Leaf spessore 5+5 mm / *Description: digitally printed glass with Leaf pattern thickness 5+5 mm*



Vetro

Vetro trasparente grigio
Transparent gray glass

Vetro satinato grigio
Gray satin glass

Stampato digitale
Digitally printed

Nero | *Black*

VETRI NATURAL

Natural

SPRING



Decoro Natura / Nature pattern

LEAF



Decoro Natura nero / Nature pattern black

VALERY



Ocra / Ocher



Grigio chiaro / Light grey

DANDELION



Bianco / White



Nero / Black

COLLEZIONE

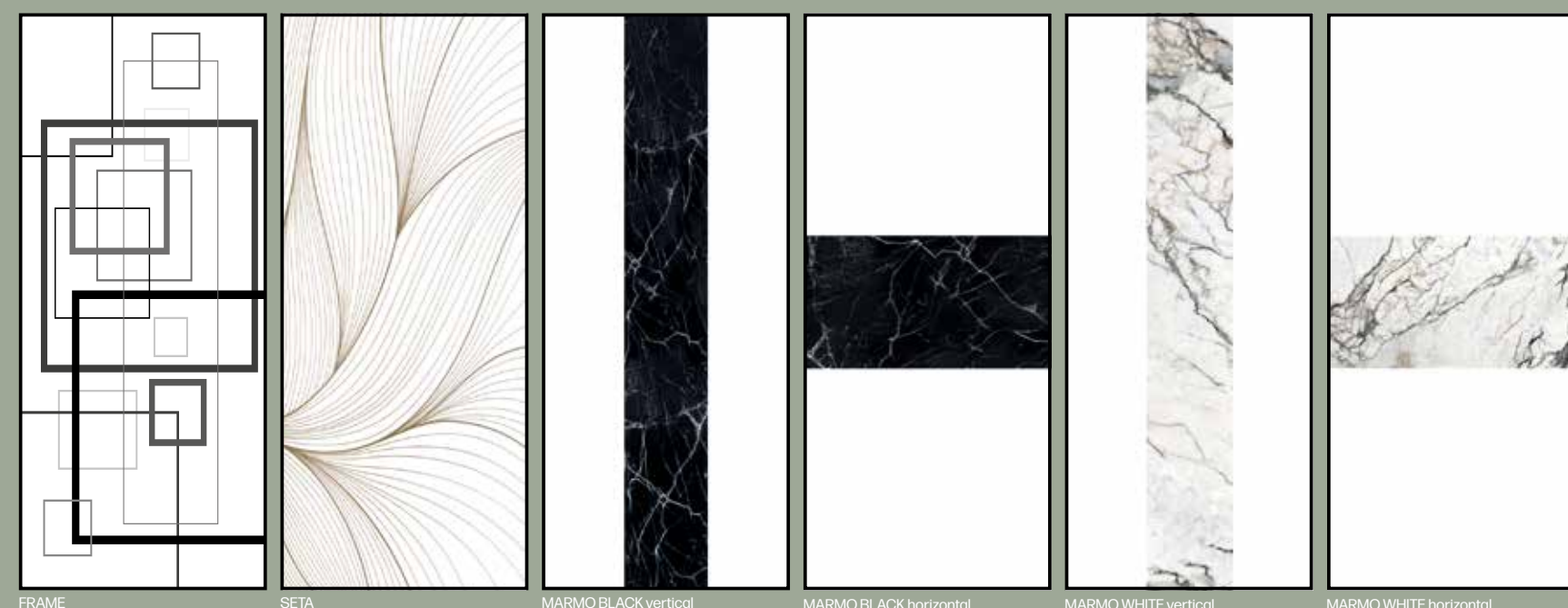
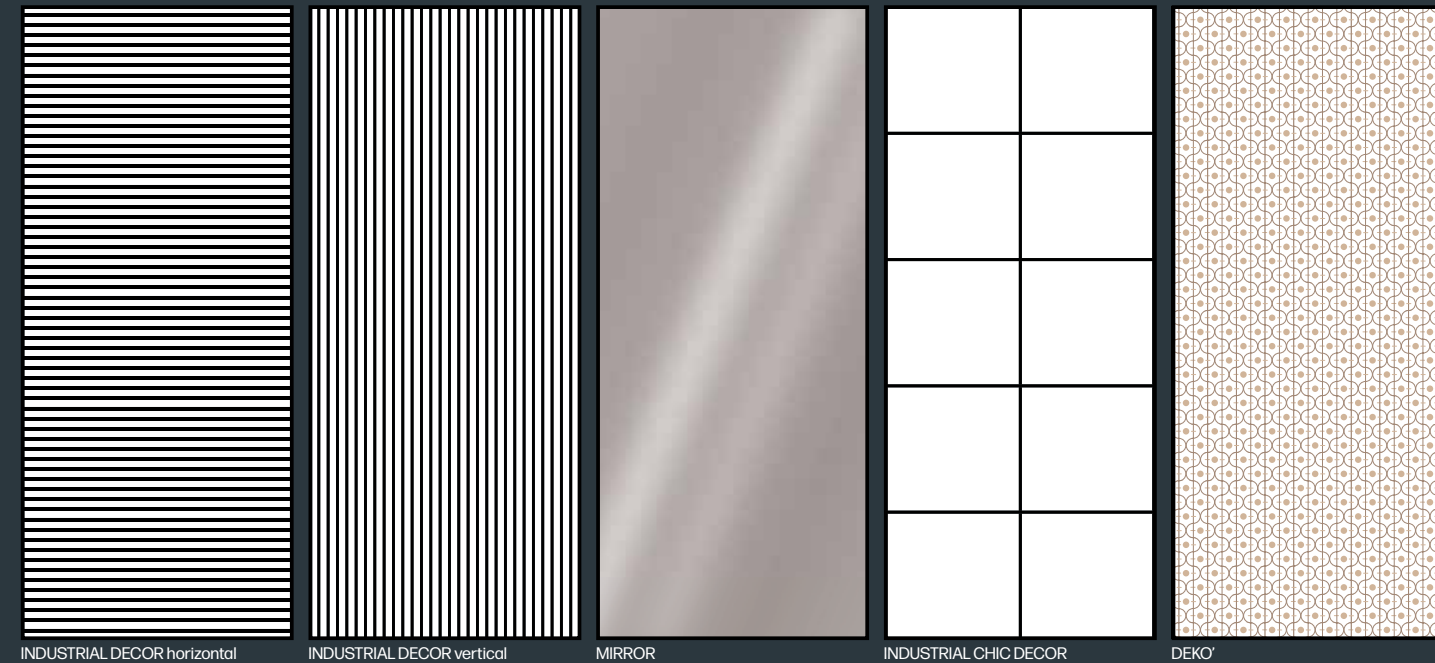

ACCESSORI E RICAMBI ANTA SCORREVOLE escluso modelli industrial

GL 5

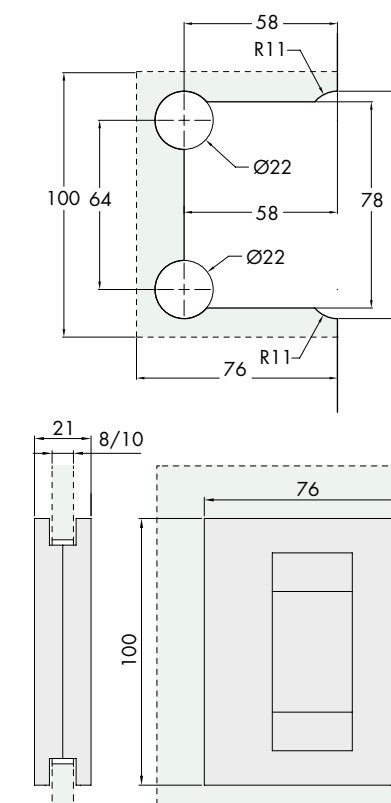

Dimensioni
H 100 mm L 76 mm

Vetro
8/10 mm

Q.tà
1 Pz

Finitura cromo - acciaio satinato - alluminio opaco

*SLIDING DOOR ACCESSORIES AND SPARE PARTS
(excluding industrial models)
Chrome finish - satin steel - matt aluminium*

MANIGLIE

GL 320

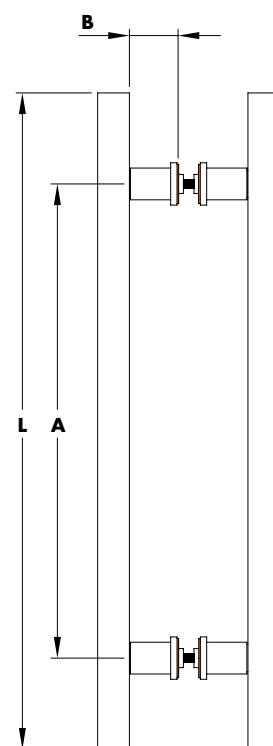
**Dimensioni**15 x 15 mm **L** 460 mm **A** 320 mm **B** 23 mm Ø**Foro vetro**

12 mm 6

Per vetro

/ 12 mm 1

Q.tà

Coppia

Finitura acciaio satinato - alluminio opaco - alluminio lucido
Satin steel finish - matt aluminum - polished aluminium

GL 2020

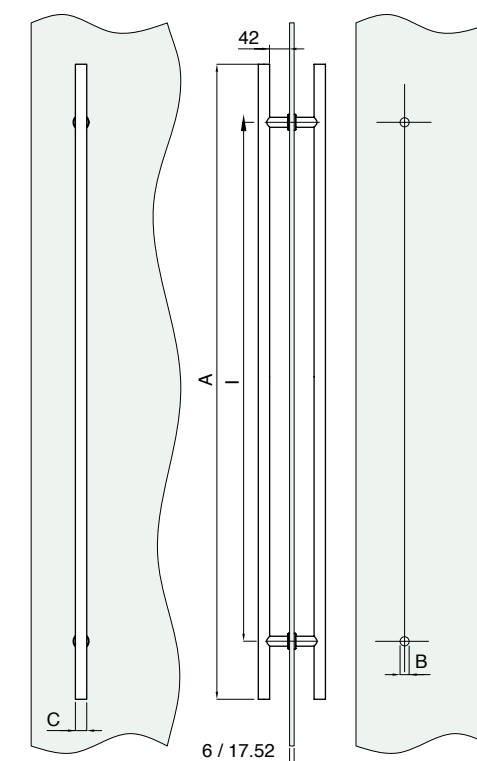
**Dimensioni****C** Ø20 mm **A** 300 mm **I** interasse 200 mm**Fori****B** minimo Ø12 mm**Vetro**

6/17.52 mm

Q.tà

Coppia

Finitura acciaio satinato - acciaio lucido
Satin steel finish - polished steel

GL 25300

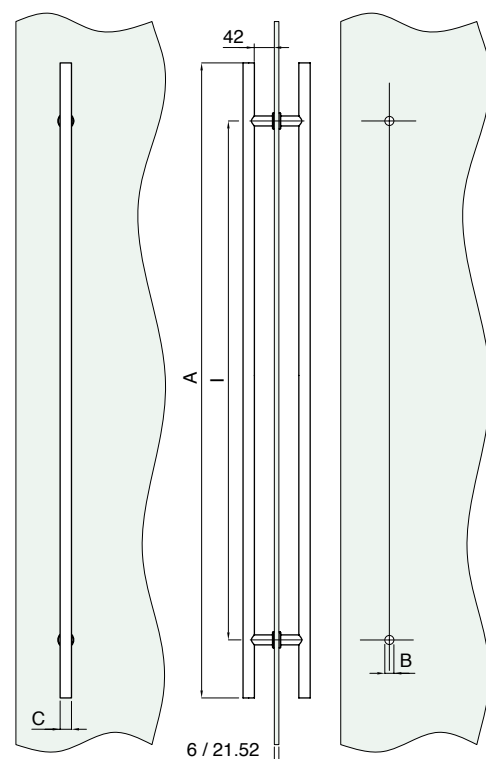
Dimensioni

C Ø25 mm A 300 mm I interasse 200 mm

Fori

B minimo Ø14 mm

Vetro

6/21.52 mm

Q.tà

1 Coppia

Finitura acciaio satinato - acciaio lucido
Satin steel finish - polished steel

GLD - MATIQUE 66

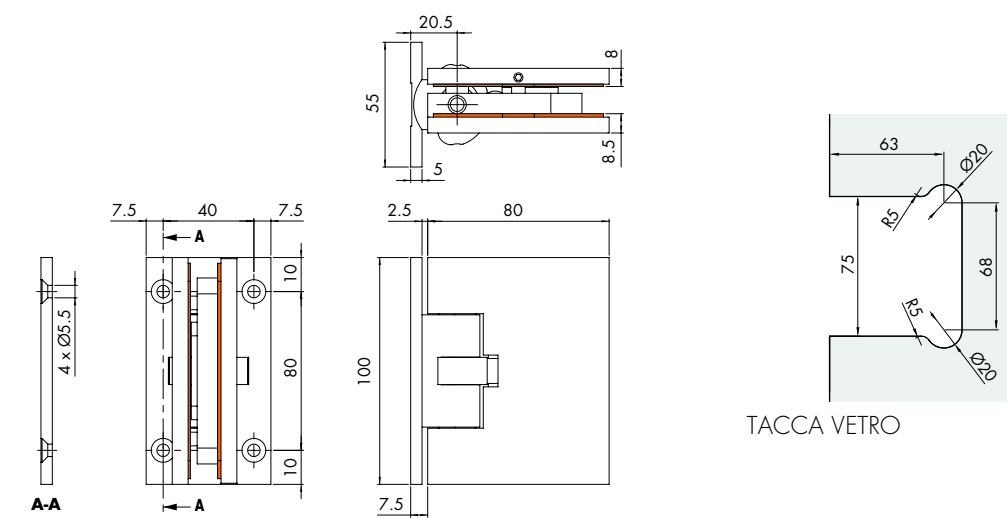
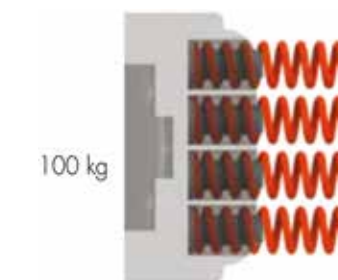
Dimensioni

L 80mm H 100mm

Vetro

10/12/6+6+1.52

Portata

100 kg

Larghezza max porta

900 mm

Q.tà

1 Pz

Cerniera vetro - muro finitura acciaio inox 304 - ottone
Glass - wall hinge in 304 stainless steel - brass finish

CERNIERE

ACCESSORI E RICAMBI ANTA SCORREVOLE

solo per i modelli industrial

MANIGLIE

GM 008

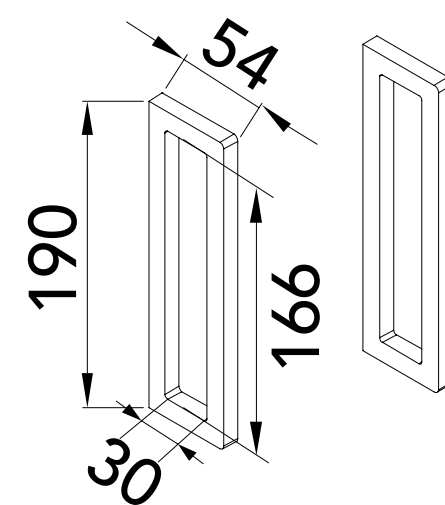

IXE
ACCIAIO SATINATO
INOX EFFECT



BC
BRONZO CHIARO
LIGHT BRONZE



BI
BIANCO OPACO
MATT WHITE

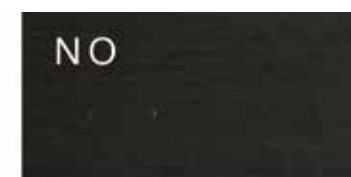

NO
NERO OPACO
MATT BLACK

SLIDING DOOR ACCESSORIES AND SPARE PARTS
only for industrial

GM 196

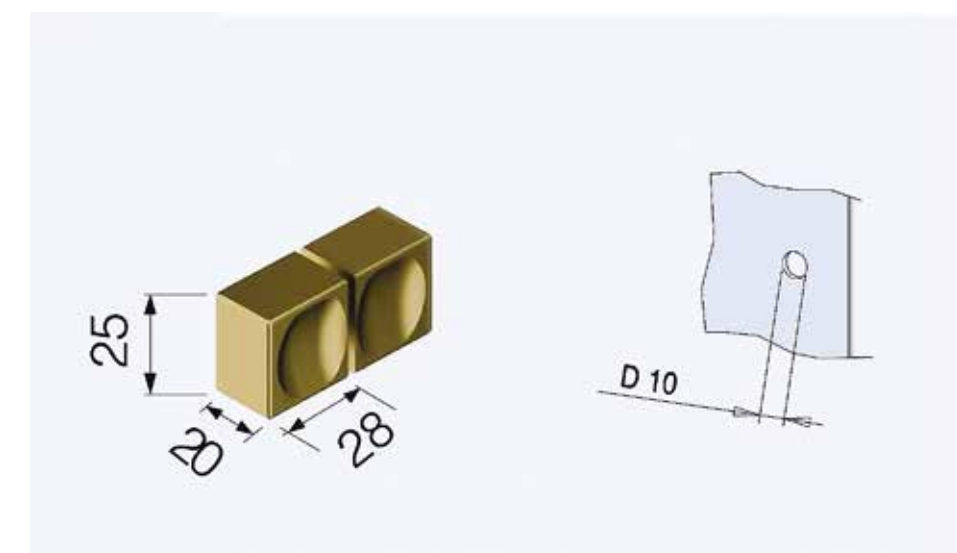

Finitura cromo - alluminio opaco - nero opaco
Chrome finish - matt aluminum - matt black



GM 008 - BIANCO OPACO / MATT WHITE



GL 25300 - ACCIAIO LUCIDO / POLISHED STEEL

Sistemi di apertura / *Opening systems*

Soluzioni disponibili / *Available solutions*

PER PORTE DUE ANTE
for two-leaf doors

GL 331 Sistemi scorrevoli - finitura acciaio satinato

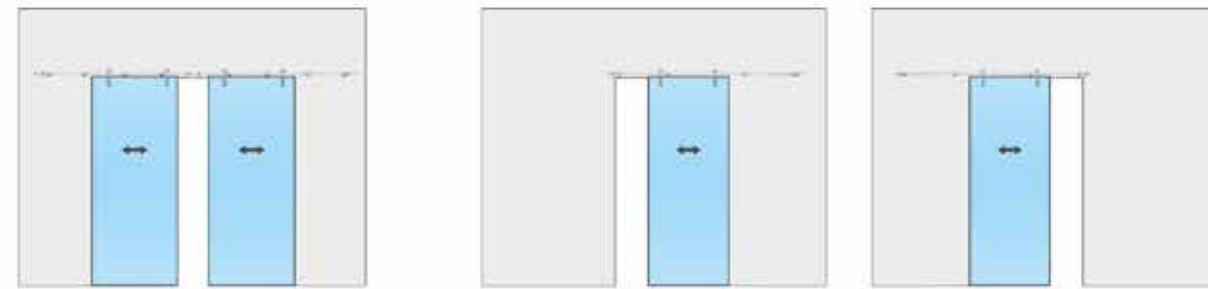

GL 355 Sistemi scorrevoli - finitura acciaio satinato

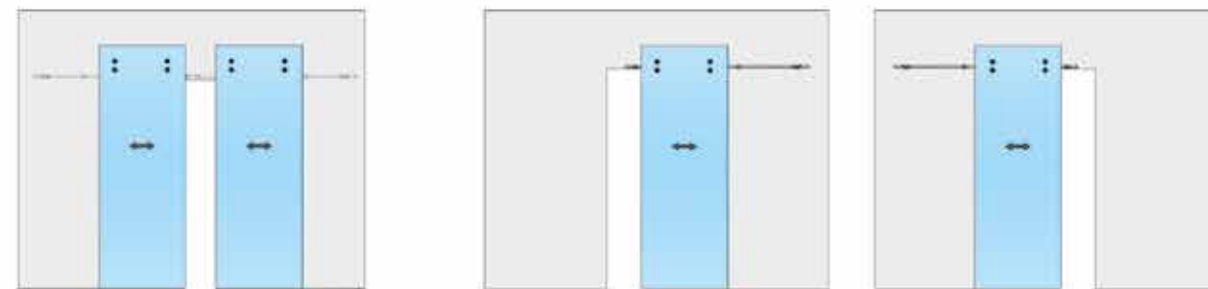

GL 443 Sistemi scorrevoli - finitura acciaio satinato / alluminio lucido / alluminio opaco

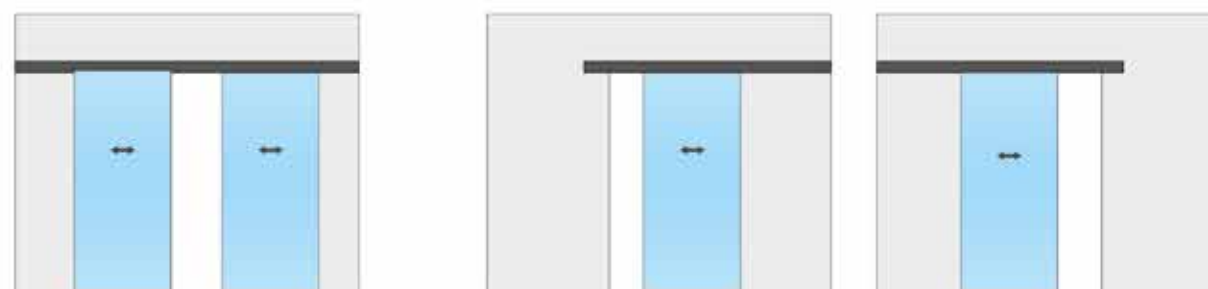

GL 454 Sistemi scorrevoli - finitura acciaio satinato / alluminio lucido / alluminio opaco

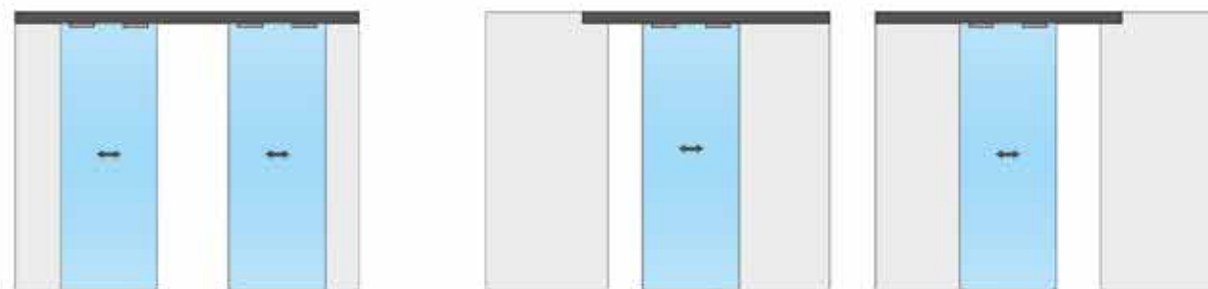

PER PORTE UN'ANTA
for single-leaf doors

GM 14 * Sistemi scorrevoli due ante
finitura acciaio satinato/nero opaco/
bronzo chiaro/bianco opaco

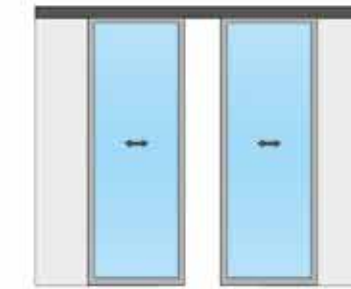

GM 14 * Sistemi scorrevoli un'anta
finitura acciaio satinato/nero opaco/
bronzo chiaro/bianco opaco

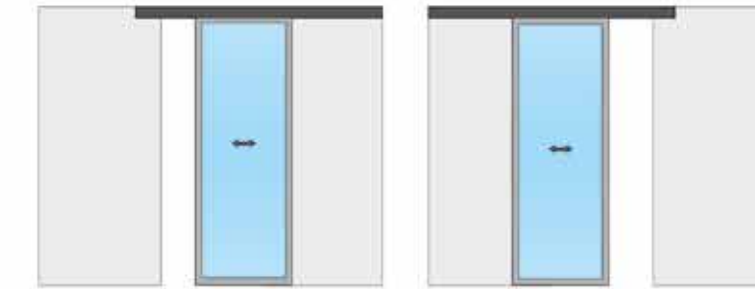

GL 328 Sistemi scorrevoli un'anta
finitura acciaio satinato

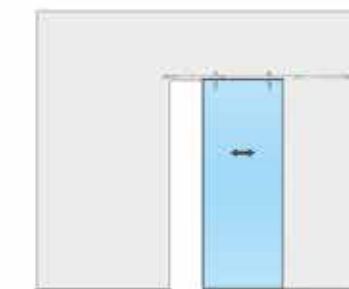

GL 448 Sistemi scorrevoli due ante
finitura acciaio satinato / alluminio lucido / alluminio opaco

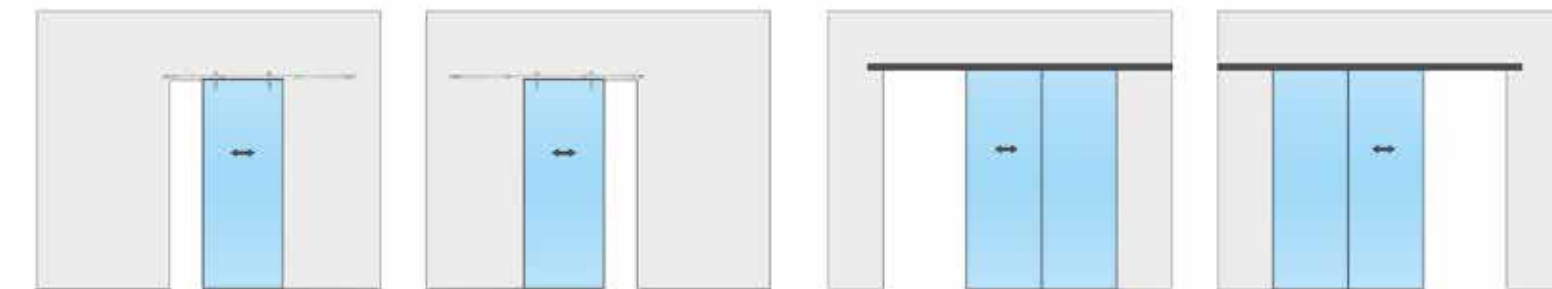

GLD MATIQUE 66 Sistema battente un'anta
finitura acciaio satinato / alluminio opaco / cromo

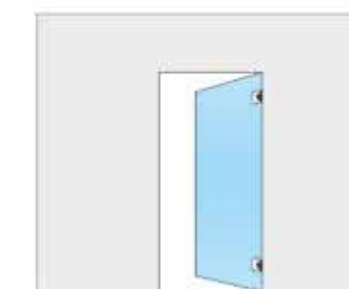

GLD MATIQUE 66 Sistema battente due ante
finitura acciaio satinato / alluminio opaco/cromo



GL 331 Sliding systems - satin steel finish

GL 335 Sliding systems - satin steel finish

GL 433 Sliding systems - satin steel finish / polished aluminium / matt aluminium

GL 454 Sliding systems - satin steel finish / polished aluminium / matt aluminium

GM 14 * Double-leaf sliding systems satin steel finish matt black / light bronze / matt white

GM 14 * Single-leaf sliding systems satin steel finish matt black / light bronze / matt white

GL 328 Single-leaf sliding systems / satin steel finish

GL 448 Double-leaf sliding systems / satin steel / polished aluminium / matt aluminium finish.

GLD MATIQUE 66 Single-leaf hinged systems / satin steel / matt aluminium / chrome finish.

GLD MATIQUE 66 Double-leaf hinged system / satin steel / matt aluminium / chrome finish

*solo per i modelli Urban / *For urban models only*

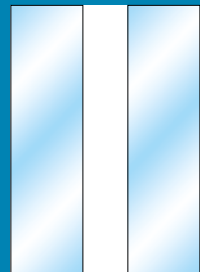

GL 331

APERTURA SCORREVOLE ESTERNO MURO DUE ANTE CONTRAPPOSTE OUTWARD SLIDING OPENING TWO OPPOSING LEAVES

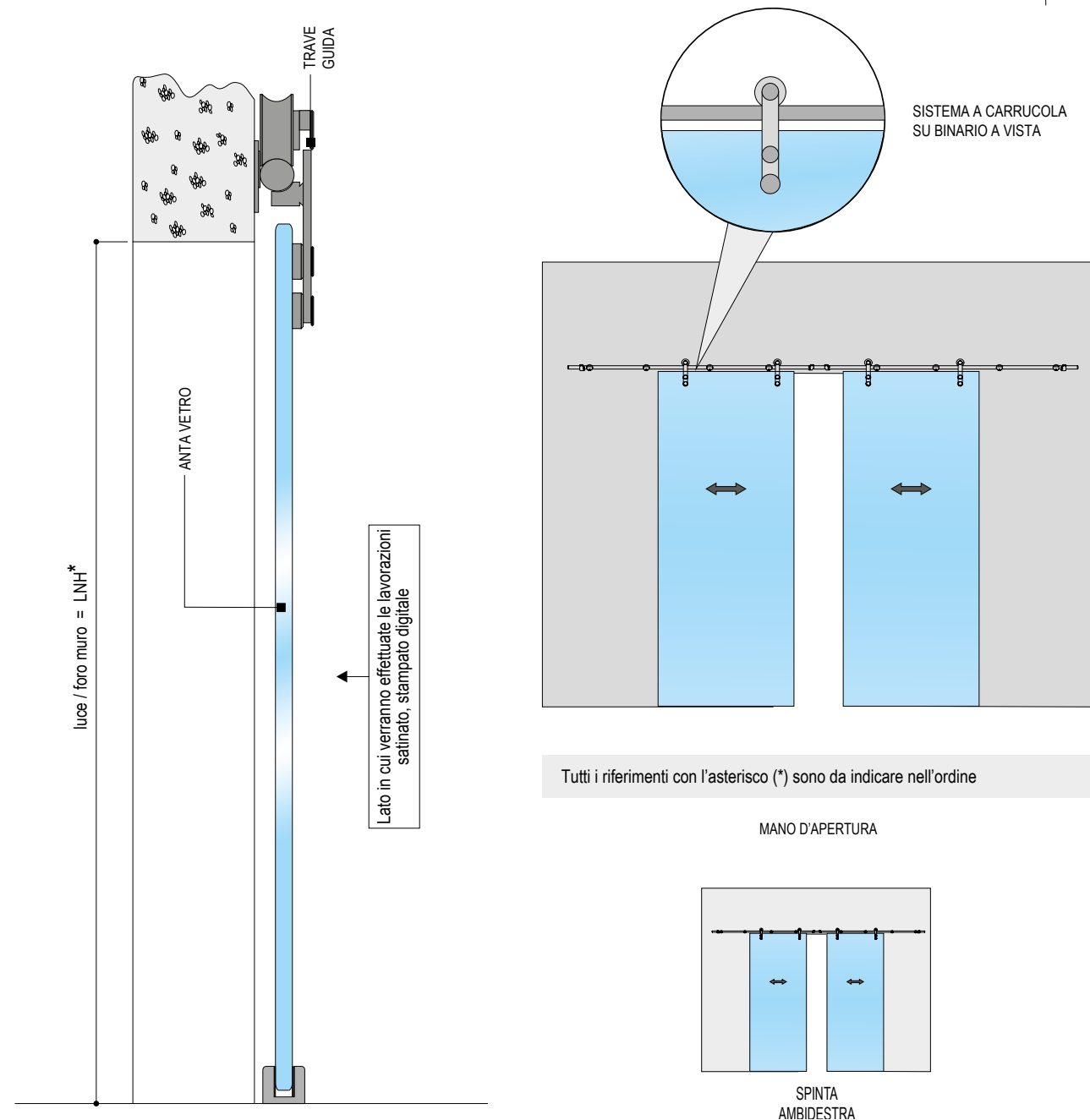
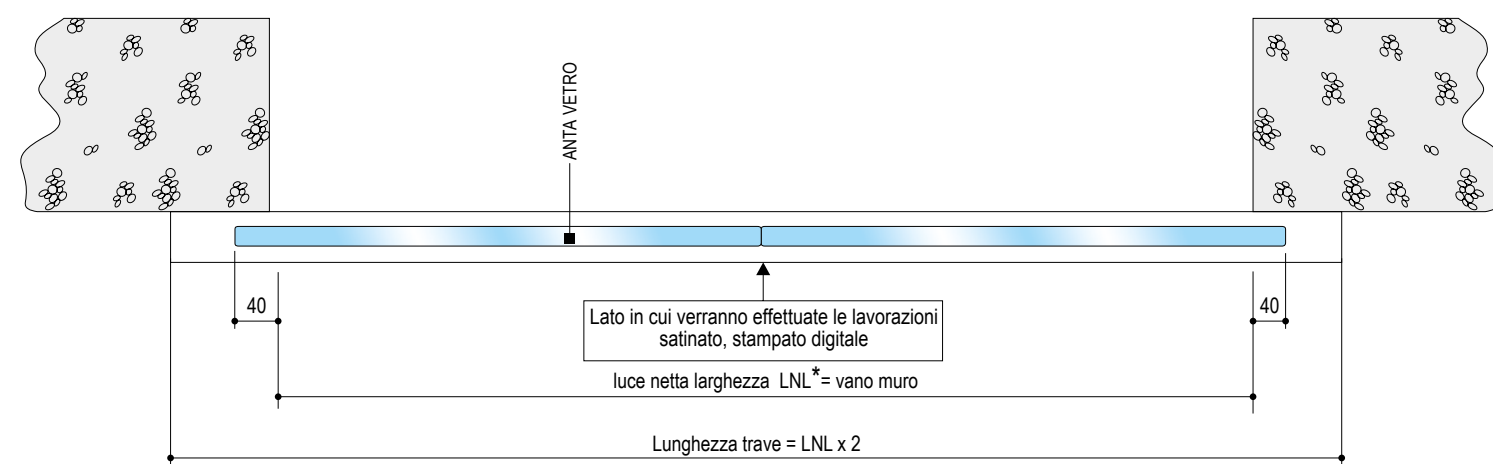

Tutti i riferimenti con l'asterisco (*) sono da indicare nell'ordine

GL 331

APERTURA SCORREVOLE ESTERNO MURO AD UN'ANTA OUTWARD SLIDING OPENING SINGLE LEAF

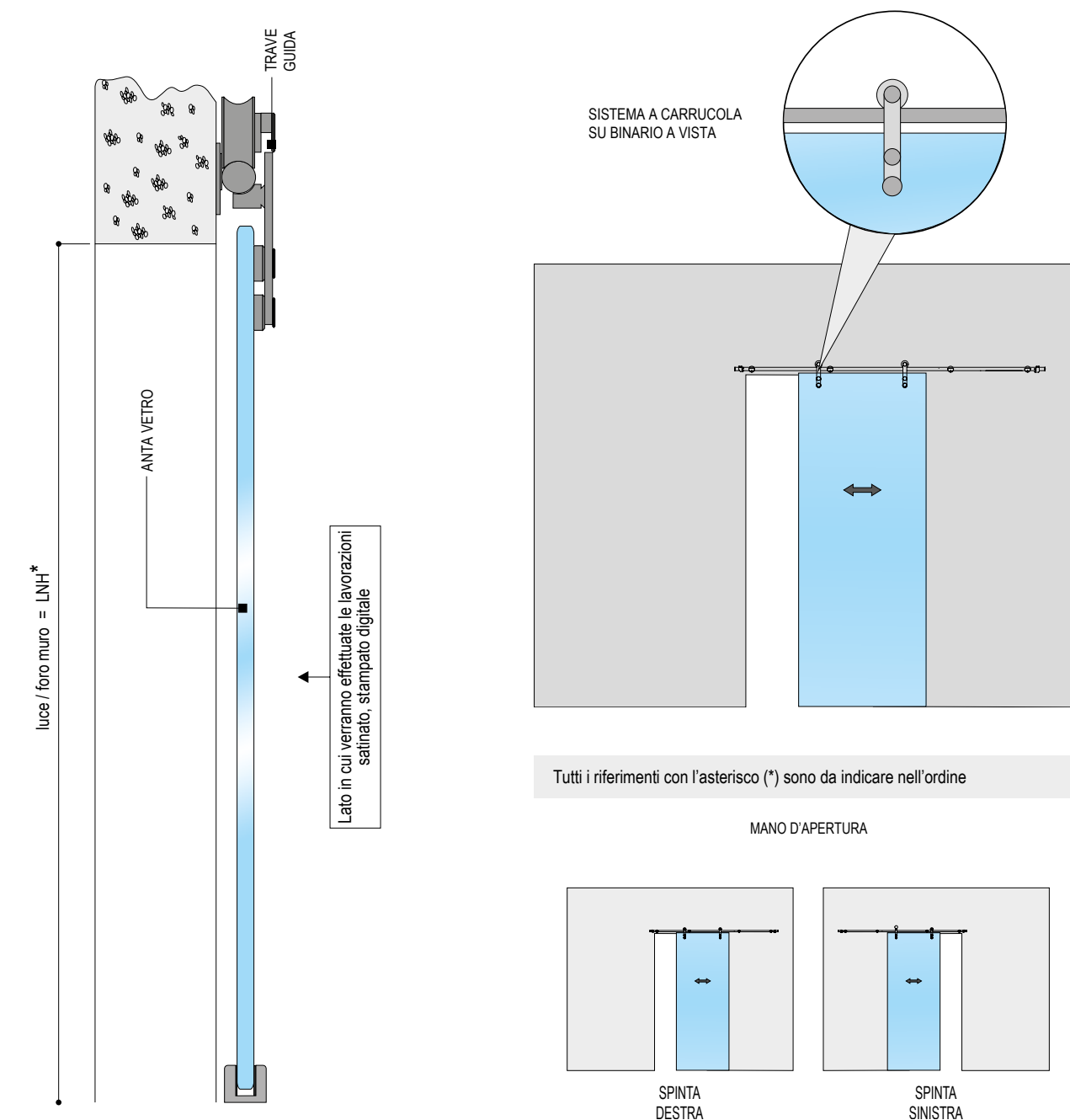
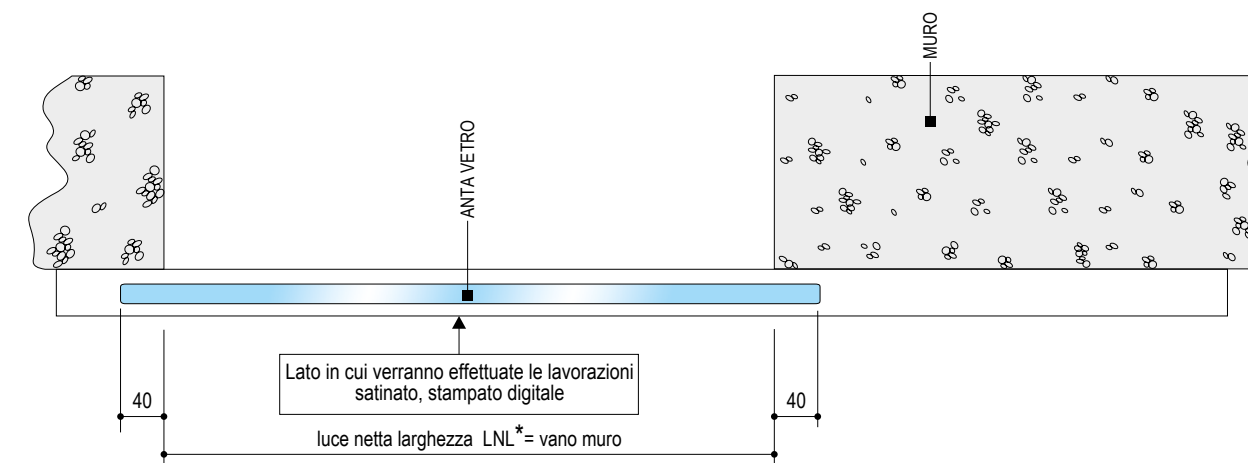

Tutti i riferimenti con l'asterisco (*) sono da indicare nell'ordine



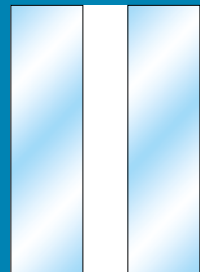

GL 355

APERTURA SCORREVOLE ESTERNO MURO DUE ANTE CONTRAPPOSTE OUTWARD SLIDING OPENING TWO OPPOSING LEAVES

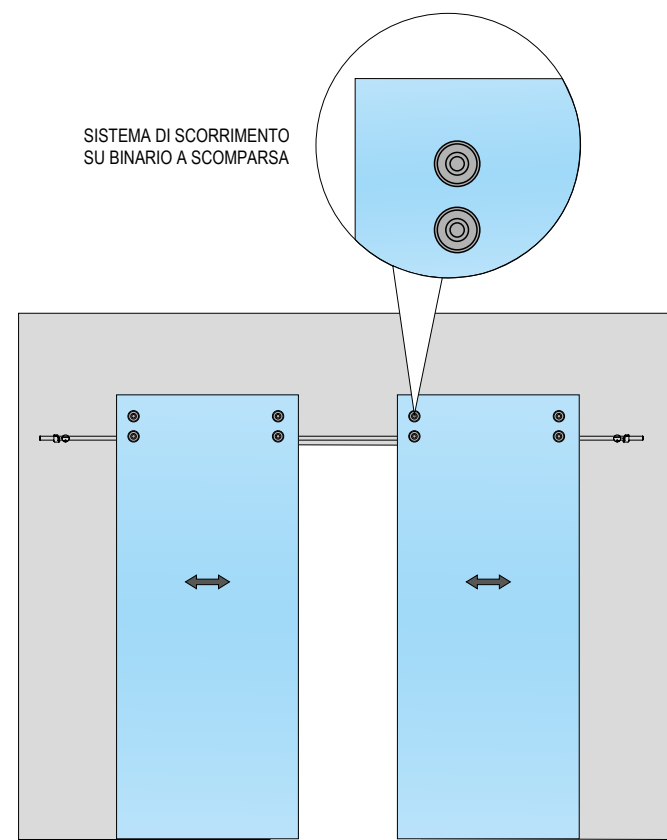
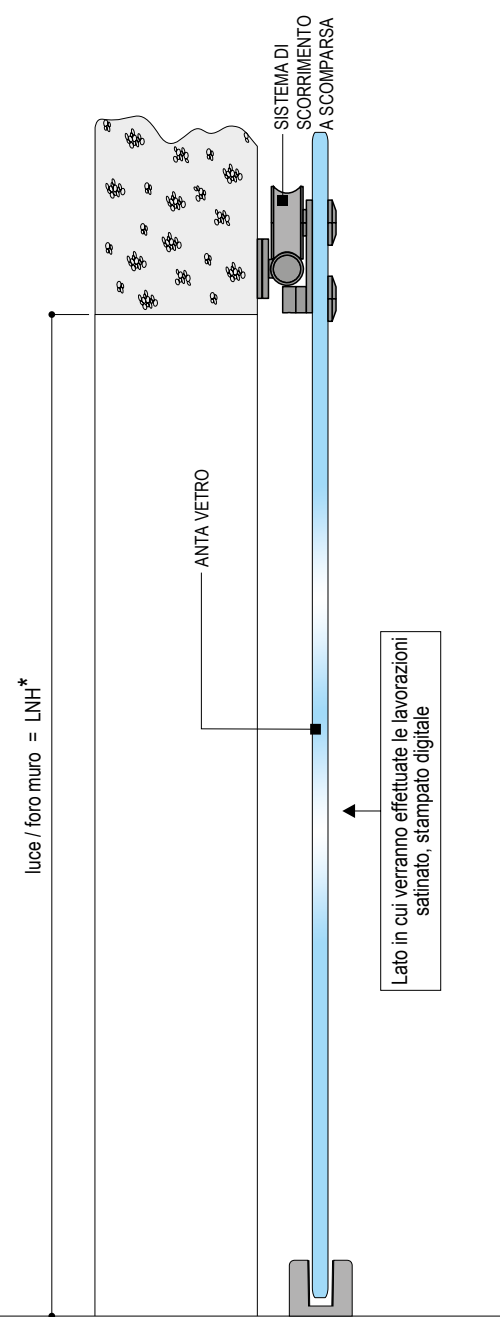
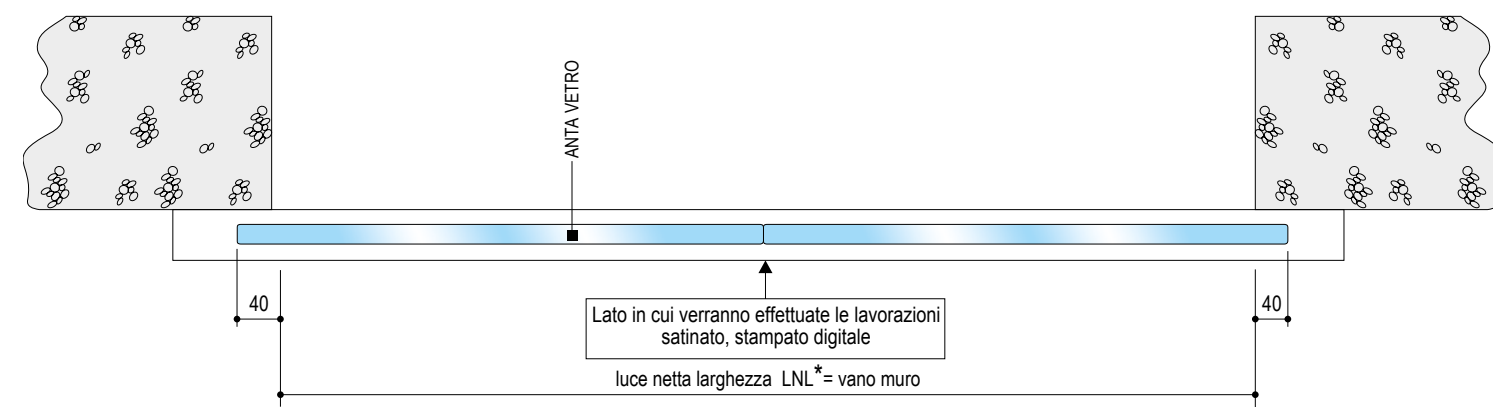

Tutti i riferimenti con l'asterisco (*) sono da indicare nell'ordine

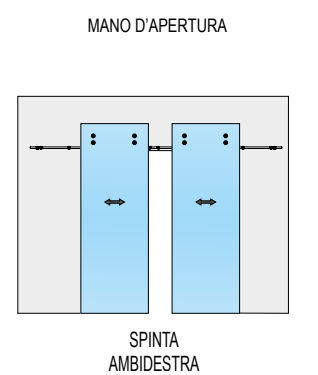

GL 355

APERTURA SCORREVOLE ESTERNO MURO AD UN'ANTA OUTWARD SLIDING OPENING SINGLE LEAF

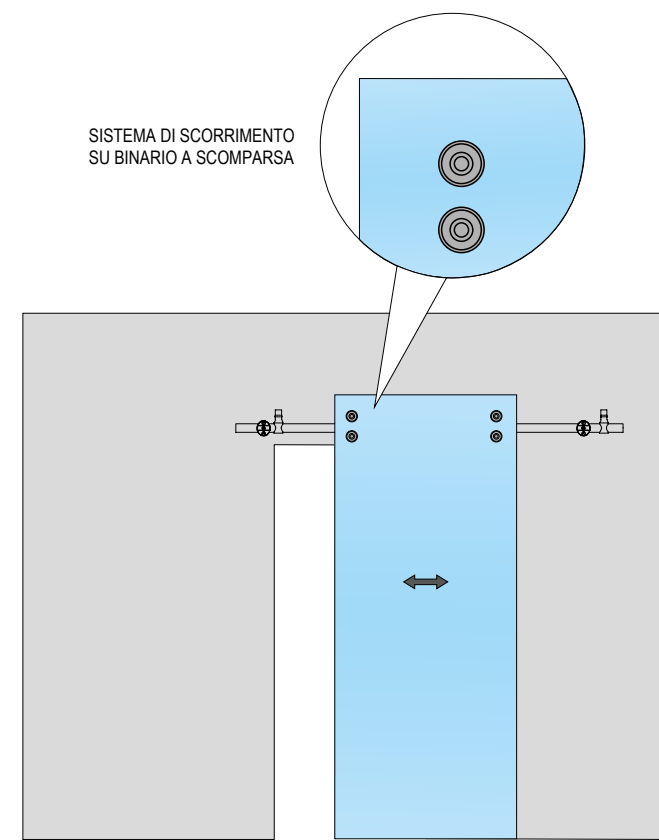
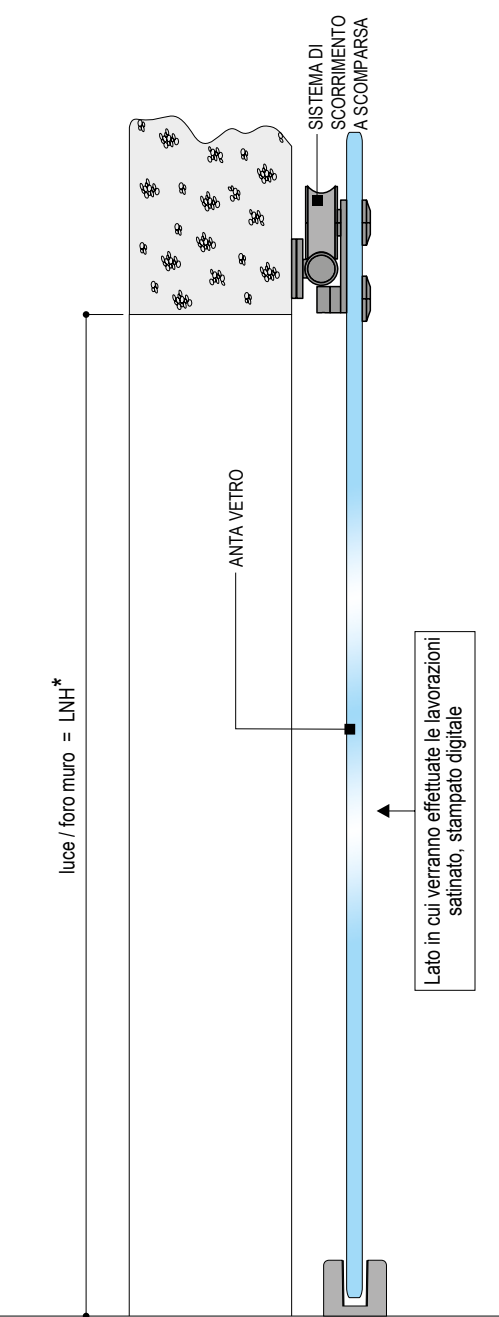
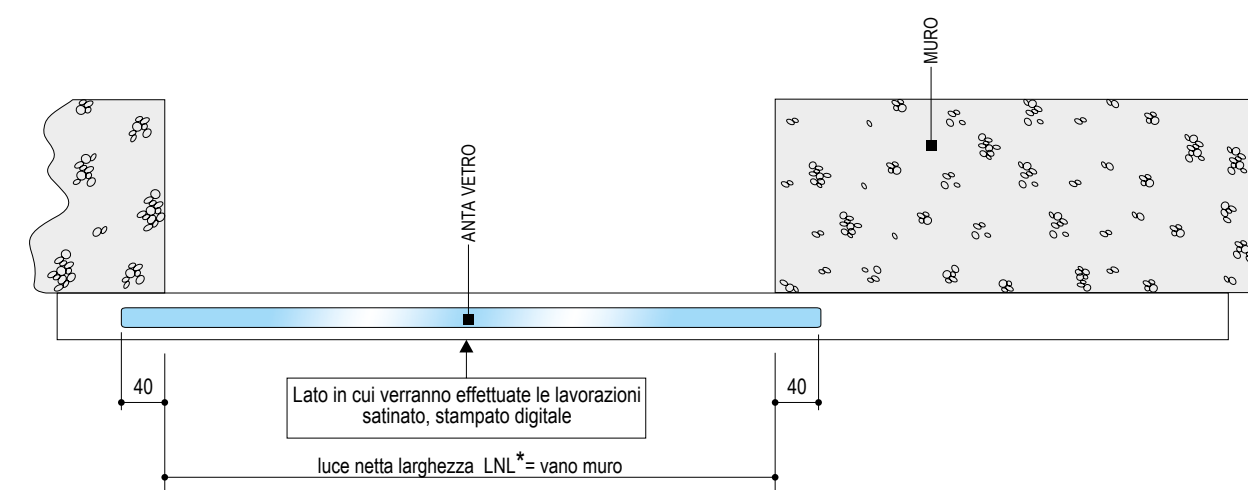

Tutti i riferimenti con l'asterisco (*) sono da indicare nell'ordine

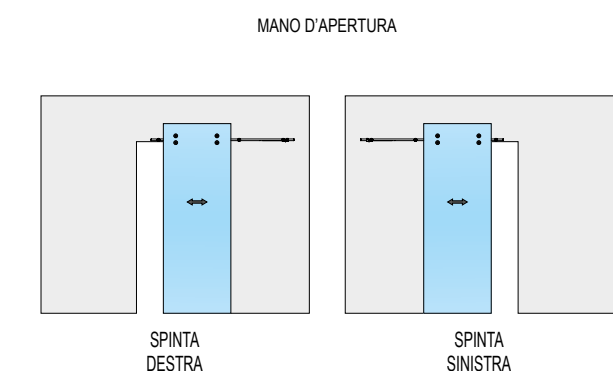

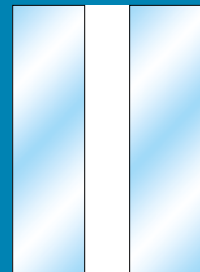

GL 443

APERTURA SCORREVOLE ESTERNO MURO DUE ANTE CONTRAPPOSTE OUTWARD SLIDING OPENING TWO OPPOSING LEAVES

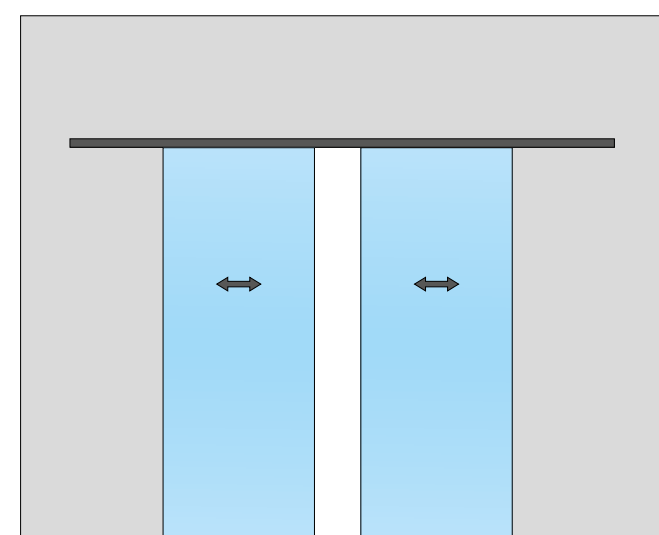
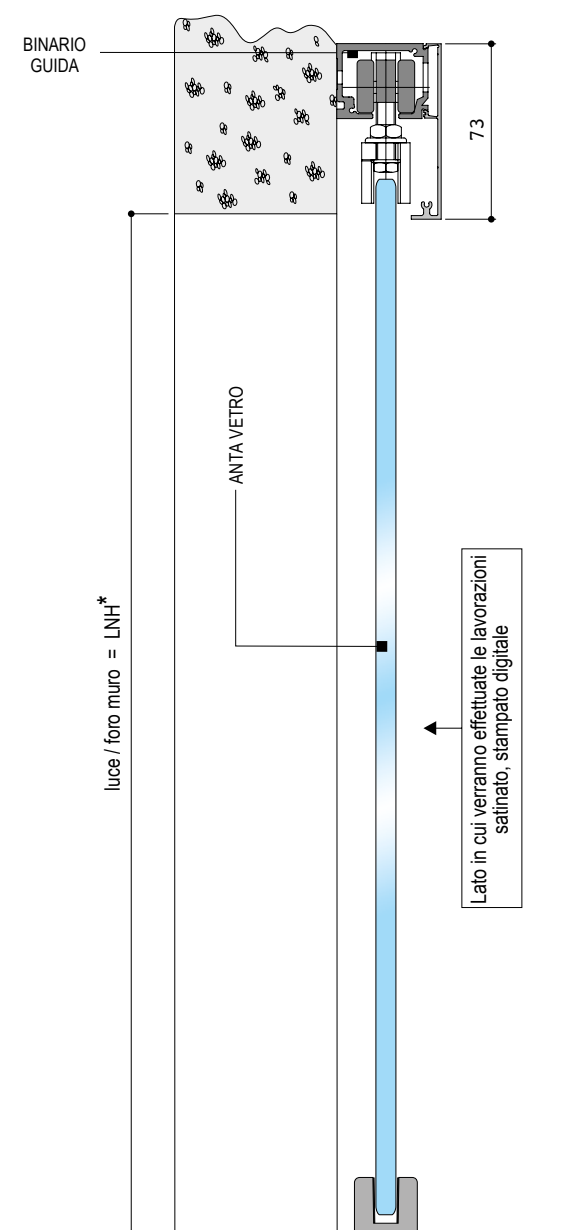
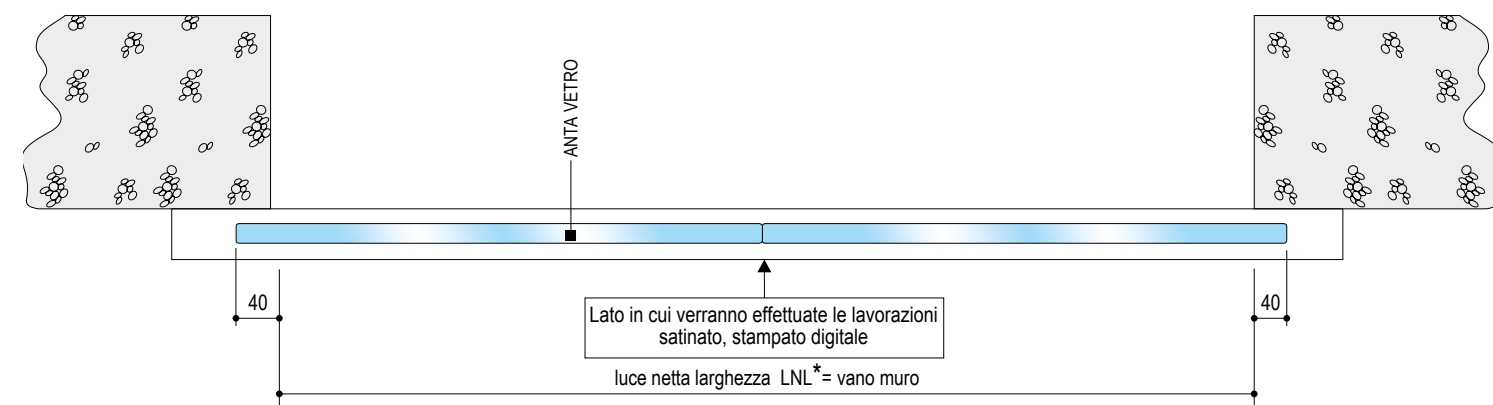

Tutti i riferimenti con l'asterisco (*) sono da indicare nell'ordine

MANO D'APERTURA

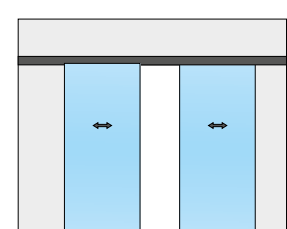

SPINTA AMBIDESTRA

GL 443

APERTURA SCORREVOLE ESTERNO MURO AD UN'ANTA OUTWARD SLIDING OPENING SINGLE LEAF

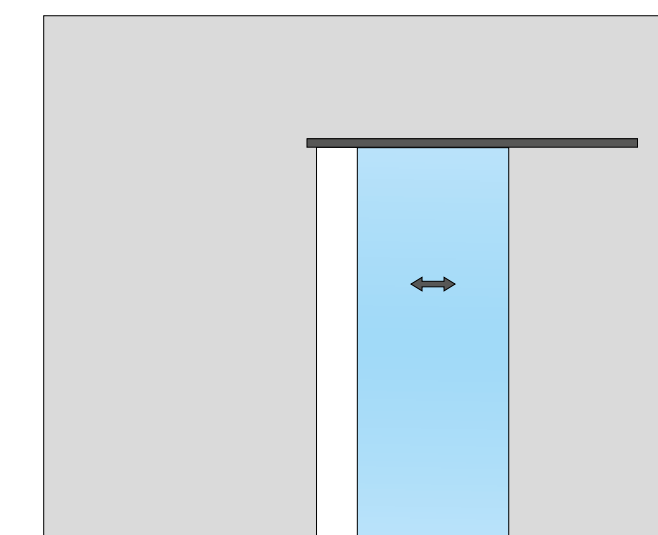
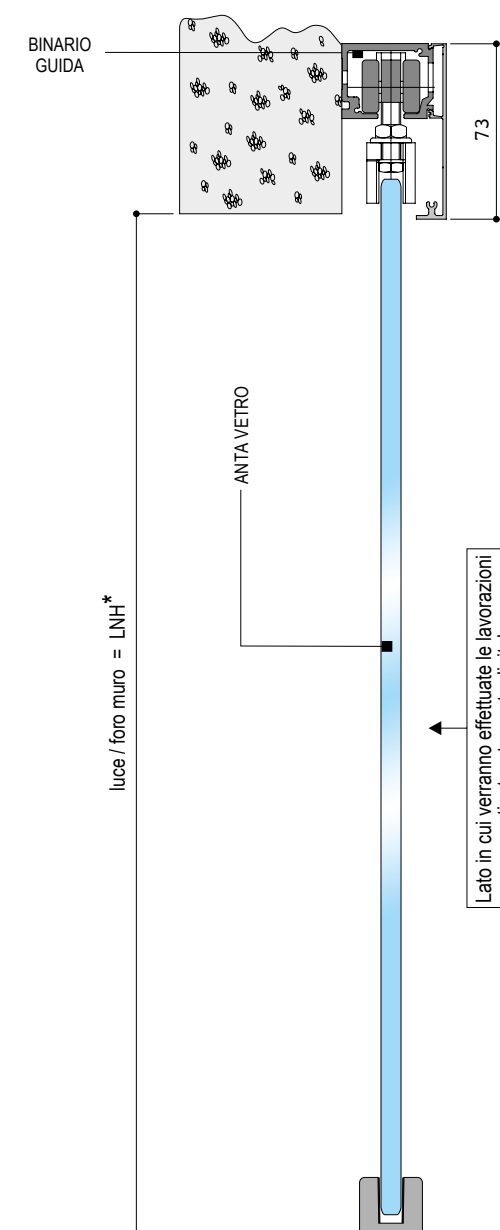
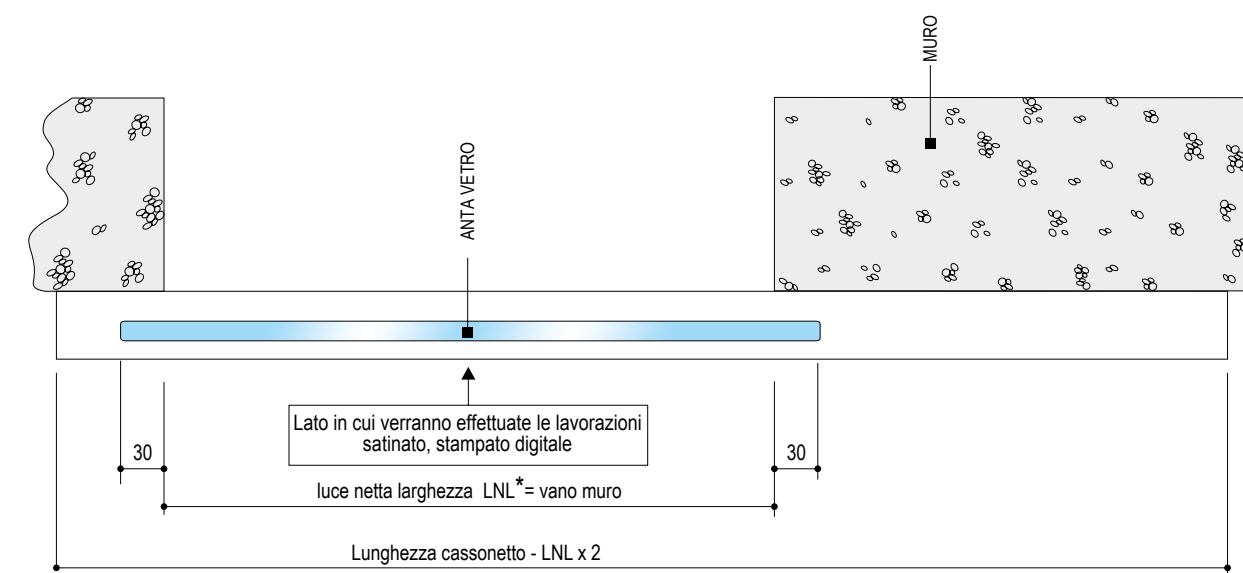

Tutti i riferimenti con l'asterisco (*) sono da indicare nell'ordine

MANO D'APERTURA

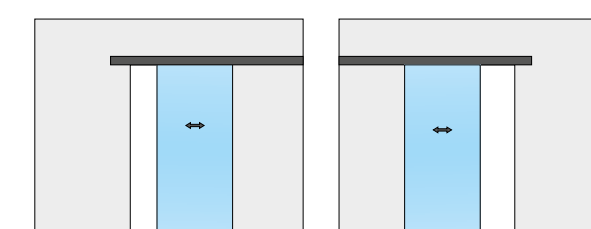

SPINTA DESTRA

SPINTA SINISTRA



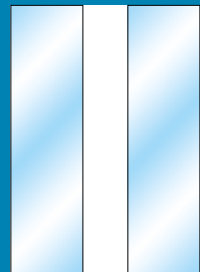

GL 454

APERTURA SCORREVOLE ESTERNO MURO DUE ANTE CONTRAPPOSTE OUTWARD SLIDING OPENING TWO OPPOSING LEAVES

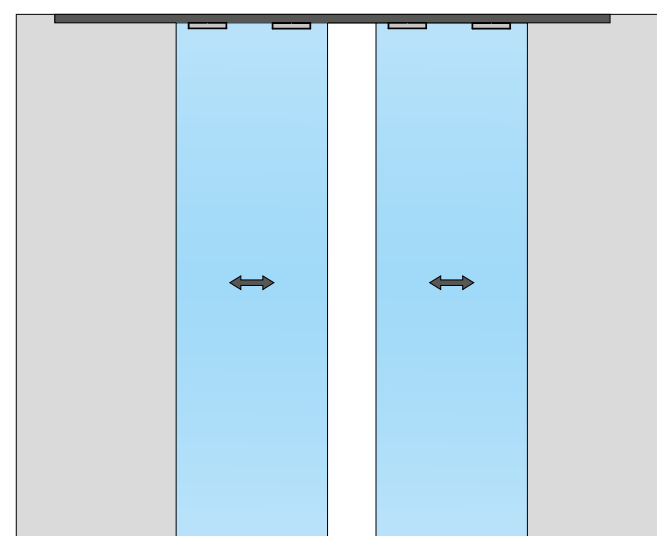
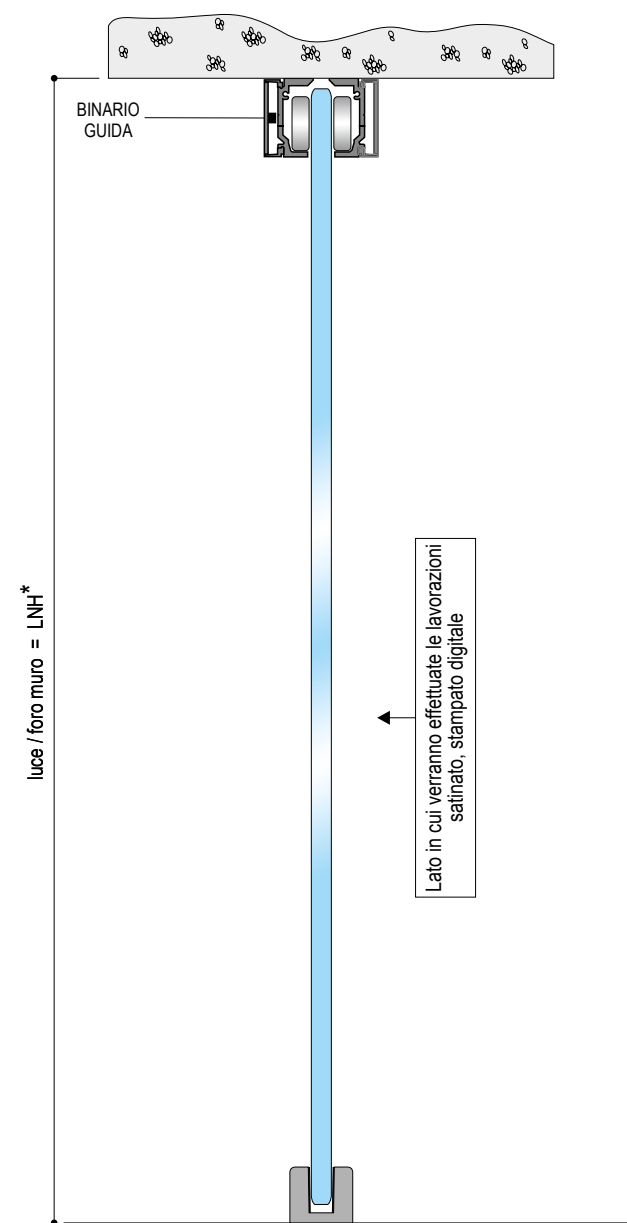
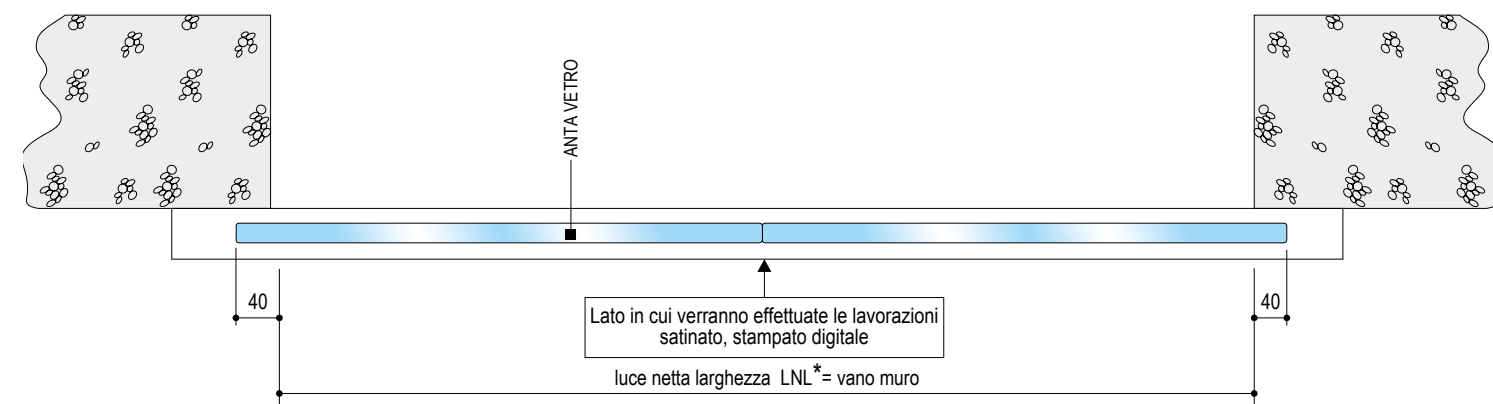

Tutti i riferimenti con l'asterisco (*) sono da indicare nell'ordine

MANO D'APERTURA

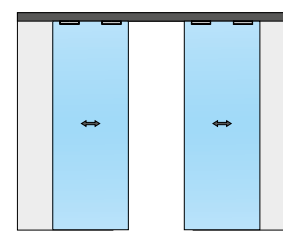

SPINTA
AMRIDFESTRA

GL 454

APERTURA SCORREVOLE ESTERNO MURO AD UN'ANTA OUTWARD SLIDING OPENING SINGLE LEAF

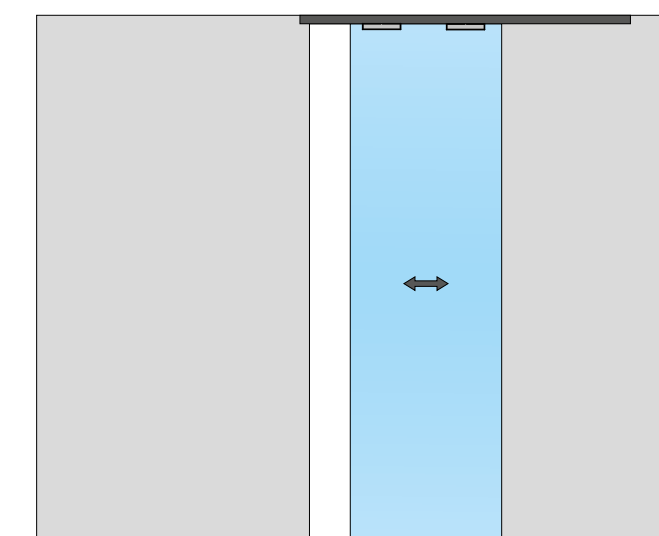
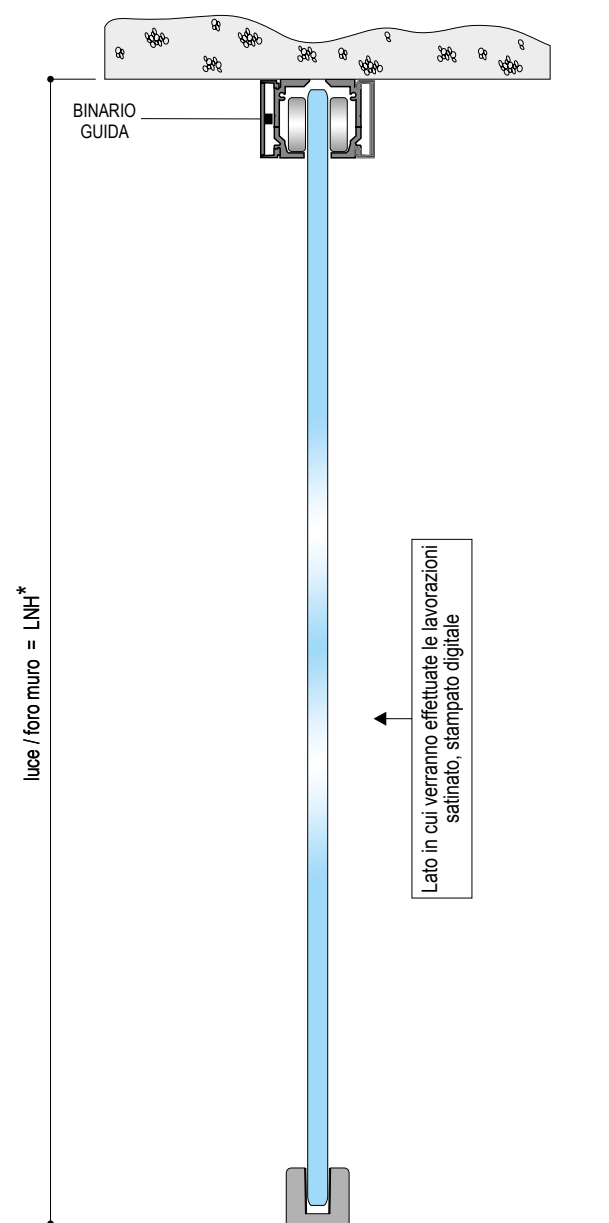
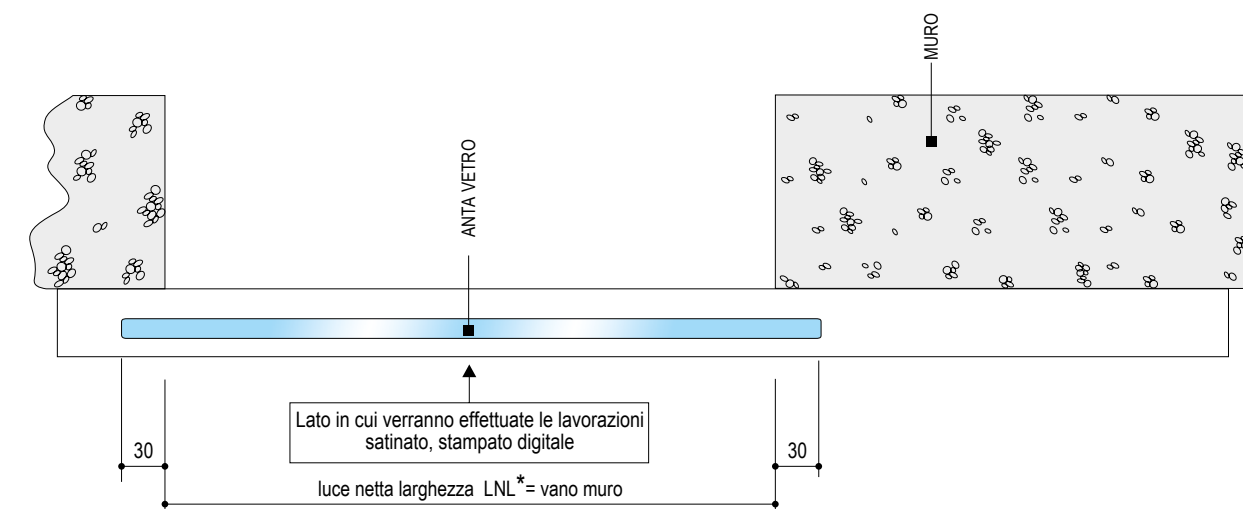

Tutti i riferimenti con l'asterisco (*) sono da indicare nell'ordine

MANO D'APERTURA

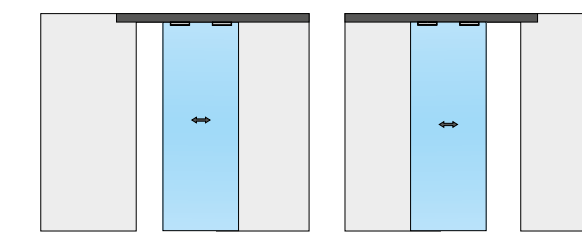

SPINTA
DESTRA

SPINTA
SINISTRA



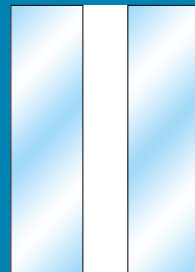

GM14

APERTURA SCORREVOLE ESTERNO MURO DUE ANTE CONTRAPPOSTE OUTWARD SLIDING OPENING TWO OPPOSING LEAVES

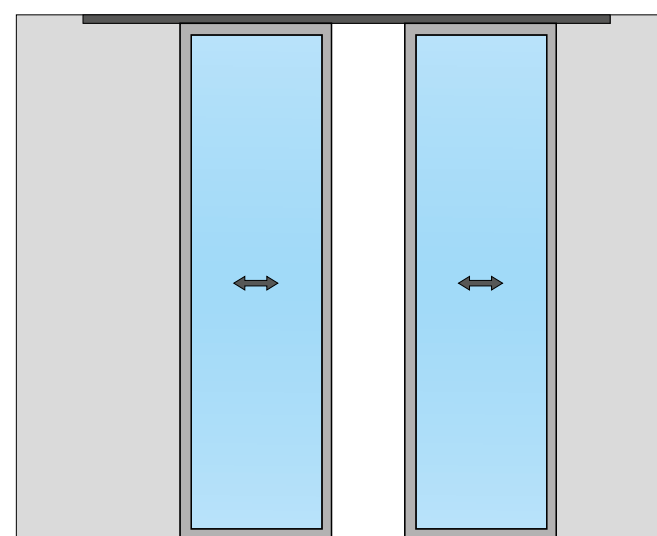
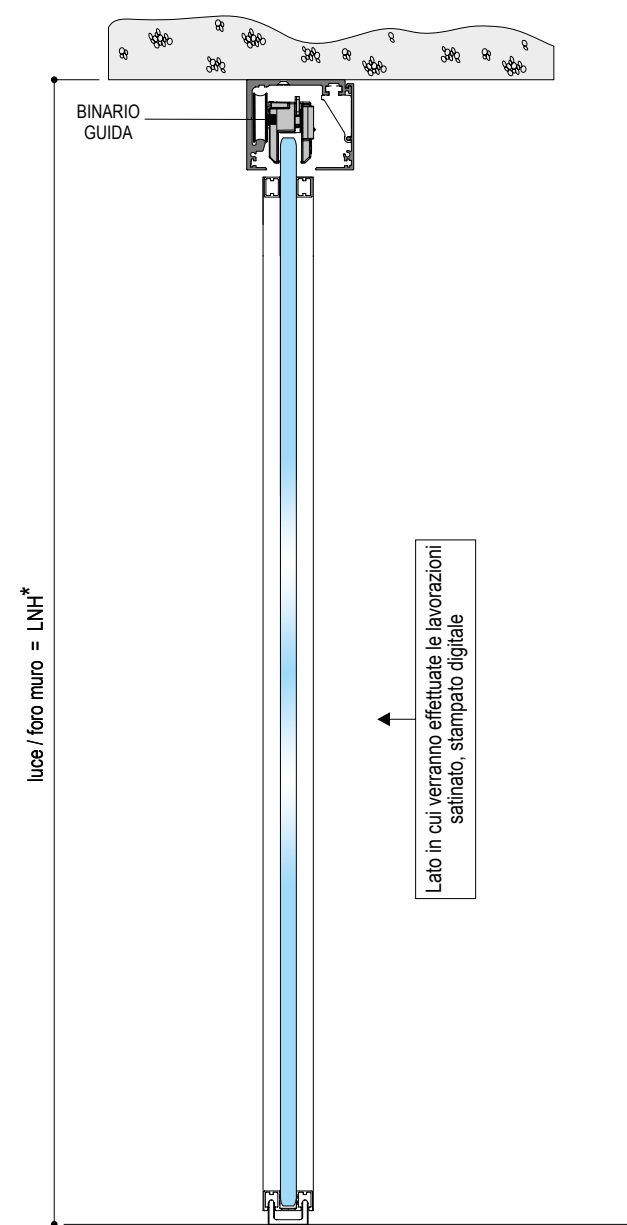
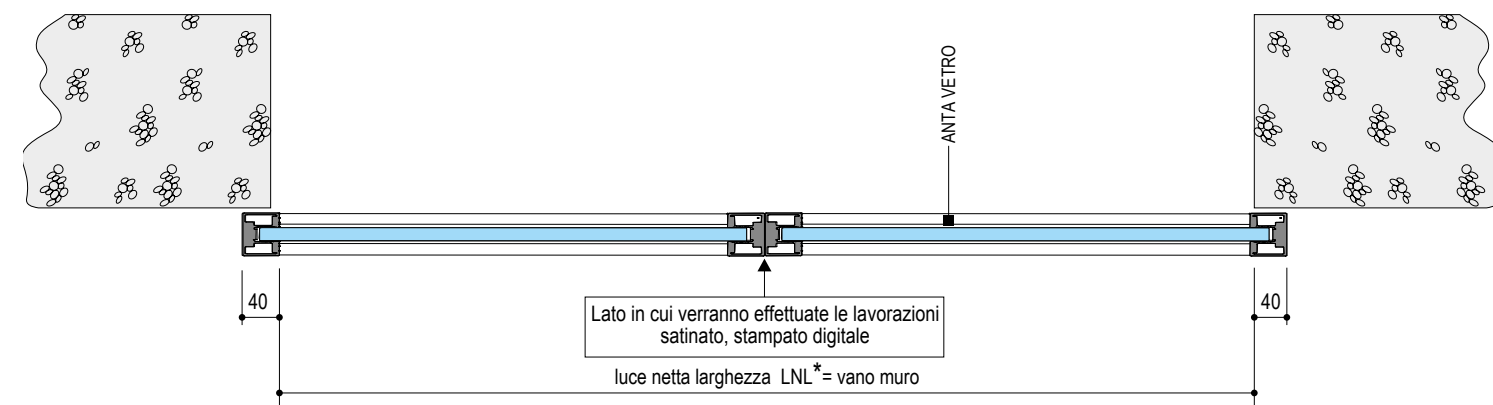

Tutti i riferimenti con l'asterisco (*) sono da indicare nell'ordine

MANO D'APERTURA

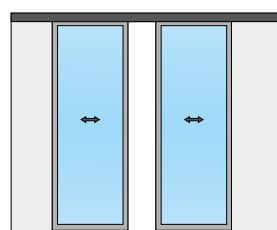

SPINTA
AMBIDESTRA

GM14

APERTURA SCORREVOLE ESTERNO MURO AD UN'ANTA OUTWARD SLIDING OPENING SINGLE LEAF

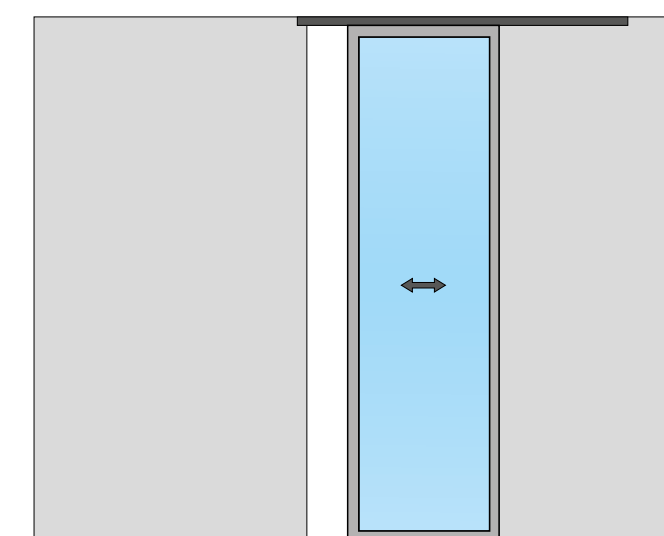
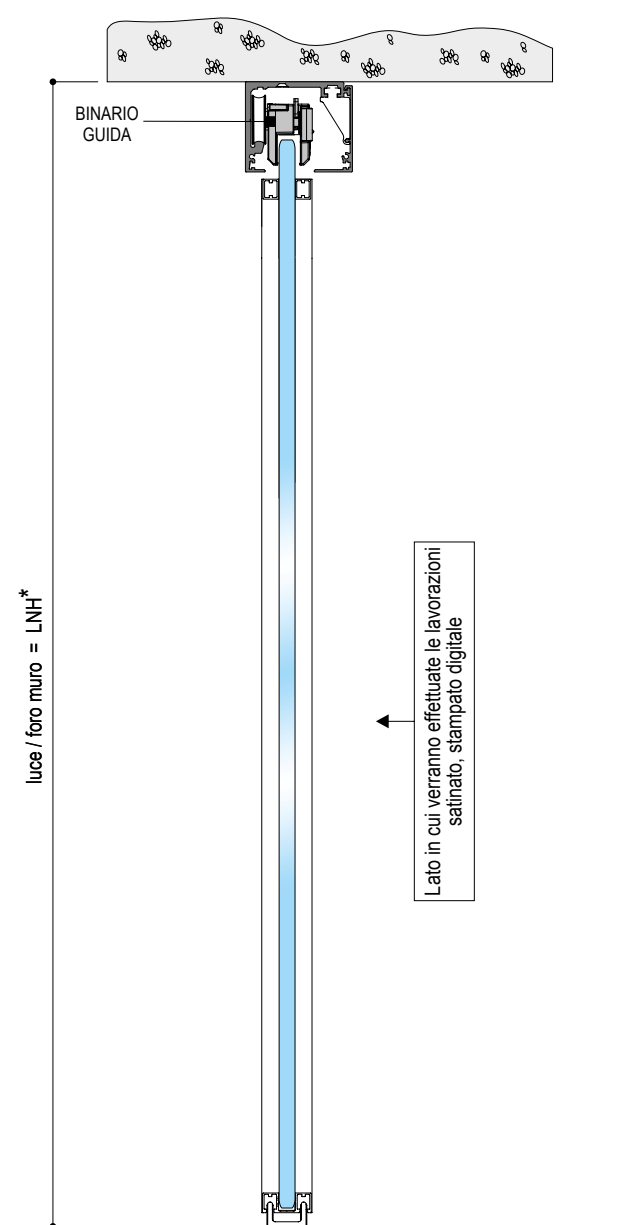
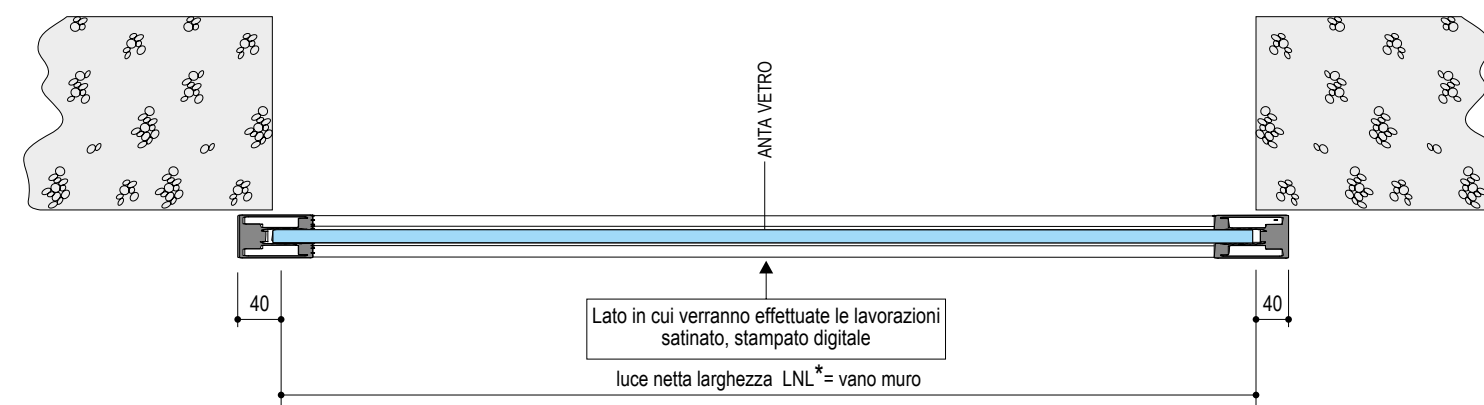

Tutti i riferimenti con l'asterisco (*) sono da indicare nell'ordine

MANO D'APERTURA

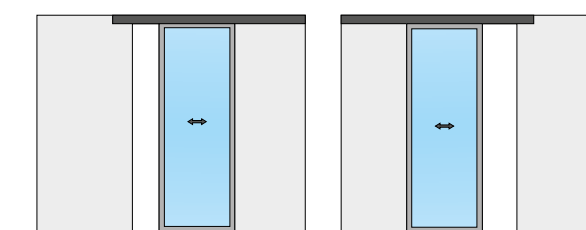

SPINTA
DESTRA

SPINTA
SINISTRA



GL 328

APERTURA SCORREVOLE ESTERNO MURO AD UN'ANTA
OUTWARD SLIDING OPENING SINGLE LEAF

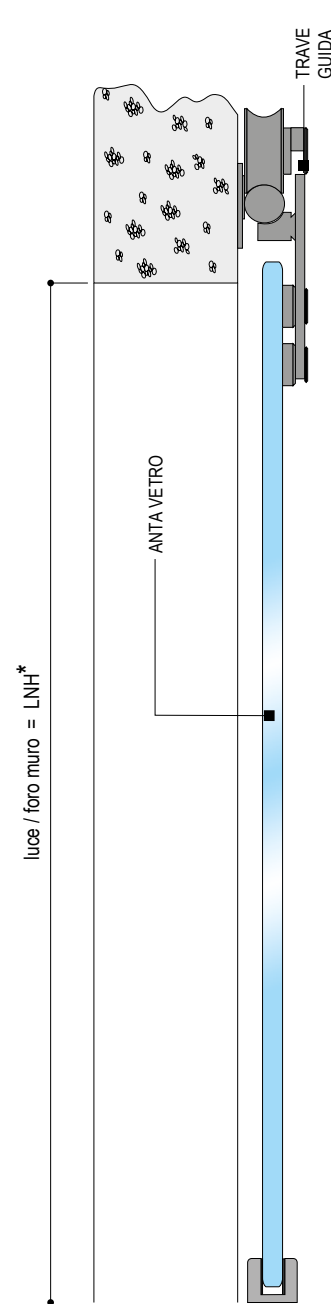
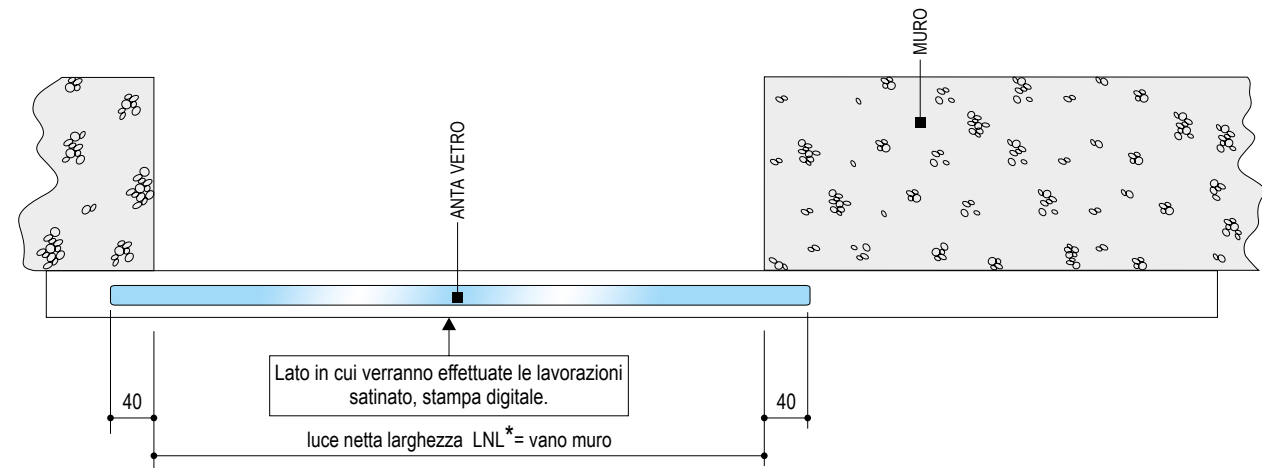

Lato in cui verranno effettuate le lavorazioni satinato, stampa digitale

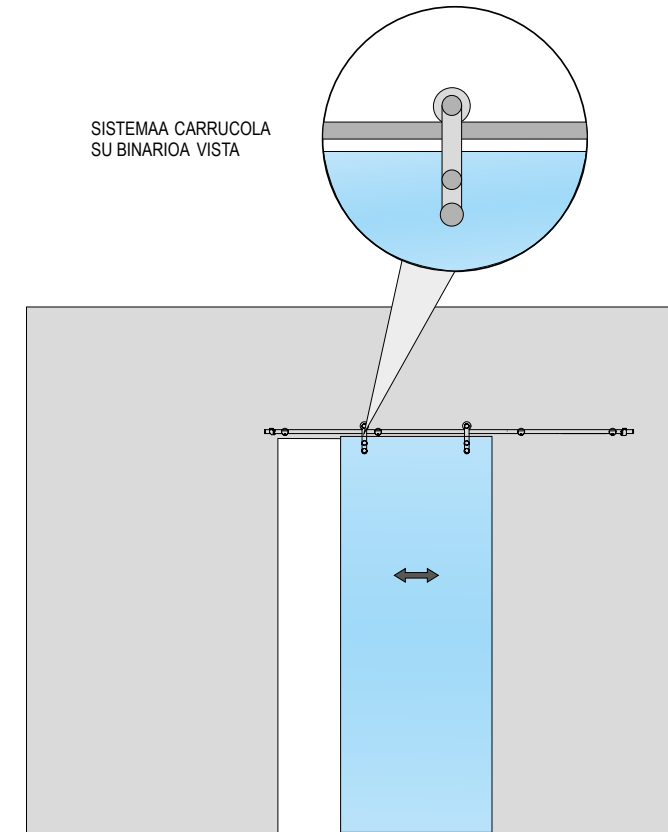

Tutti i riferimenti con l'asterisco (*) sono da indicare nell'ordine

MANO D'APERTURA

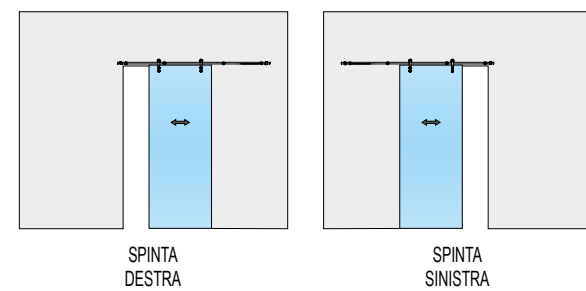

GL 448

APERTURA SCORREVOLE ESTERNO MURO DUE ANTE 1 ANTA FISSA + 1 ANTA SCORREVOLE
OUTWARD SLIDING OPENING TWO LEAVES 1 FIXED LEAF + 1 SLIDING LEAF

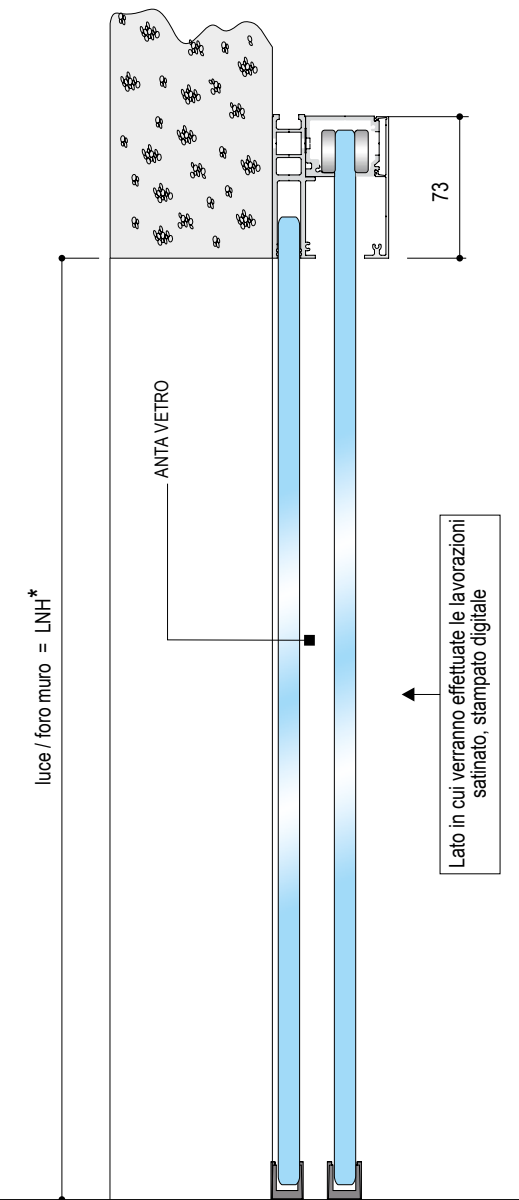
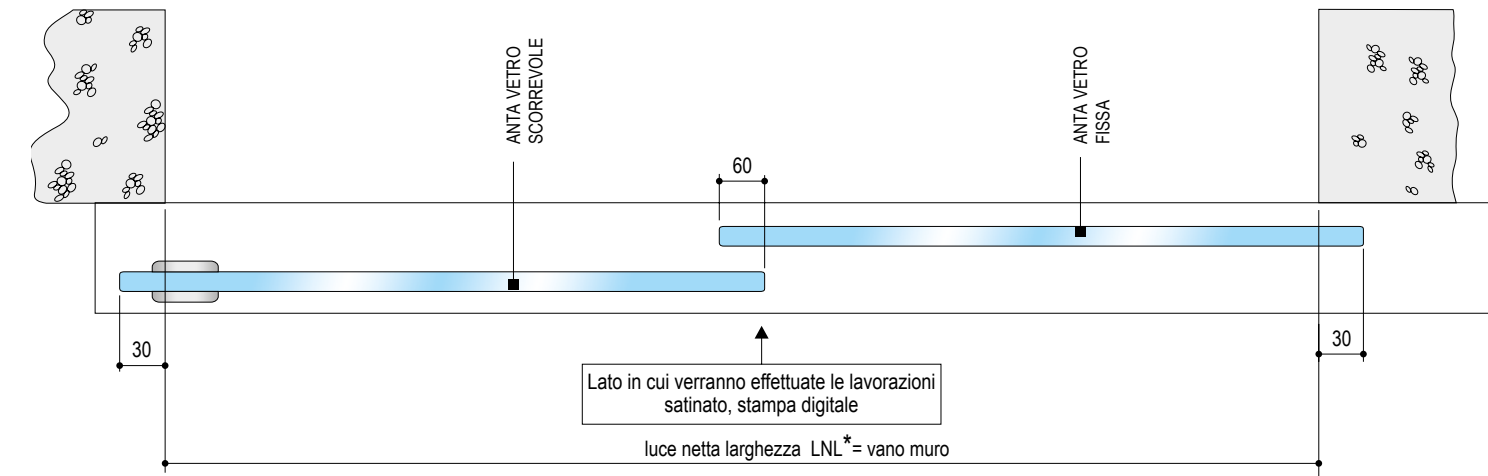

Lato in cui verranno effettuate le lavorazioni satinato, stampato digitale

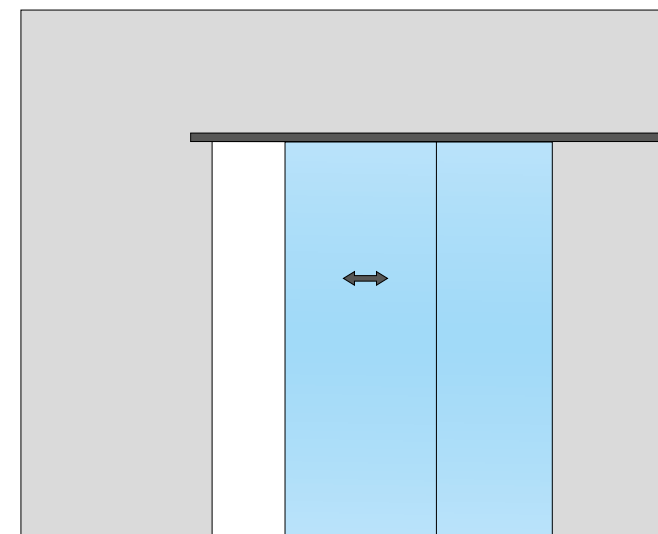

Tutti i riferimenti con l'asterisco (*) sono da indicare nell'ordine

MANO D'APERTURA

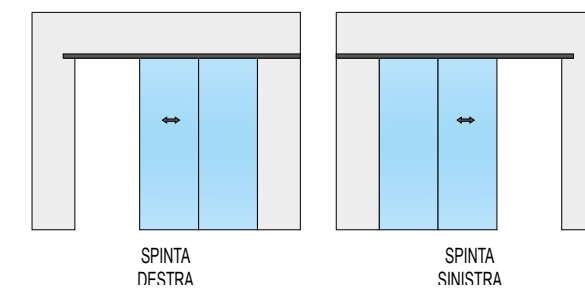

GLD MATIQUE 66

APERTURA CON CERNIERE AUTOMATICHE AD UN'ANTA
 SINGLE-LEAF OPENING WITH AUTOMATIC HINGES

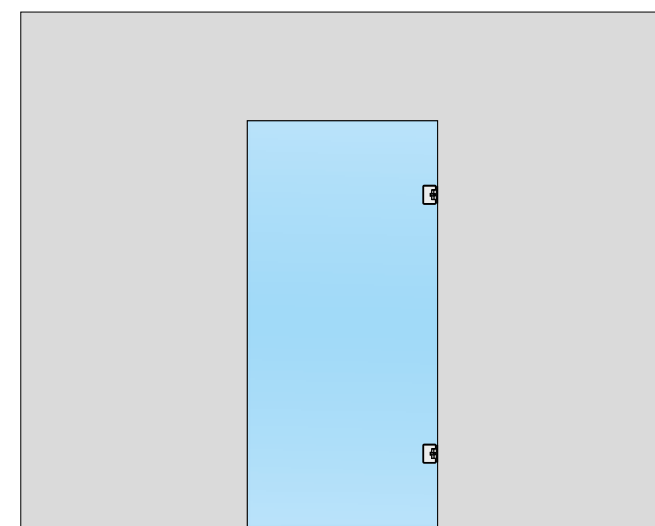
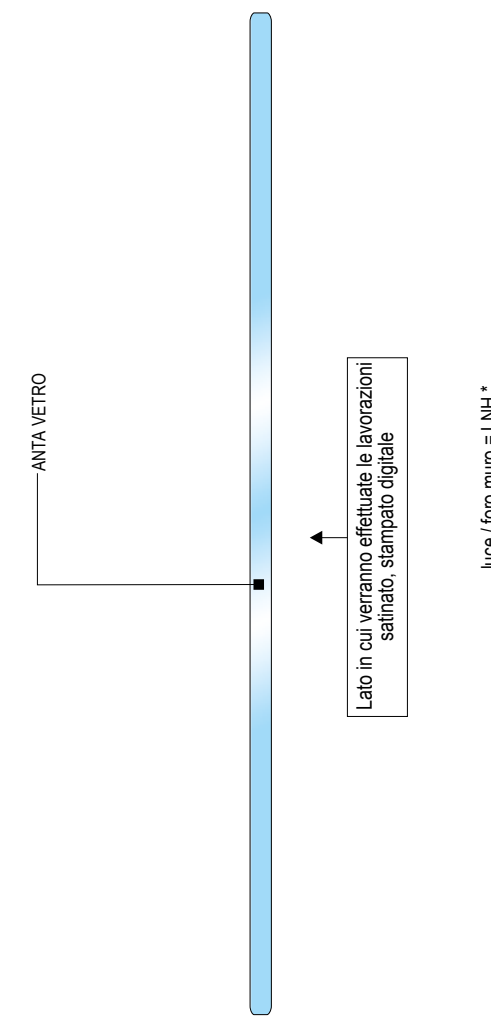
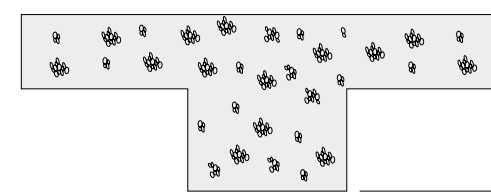
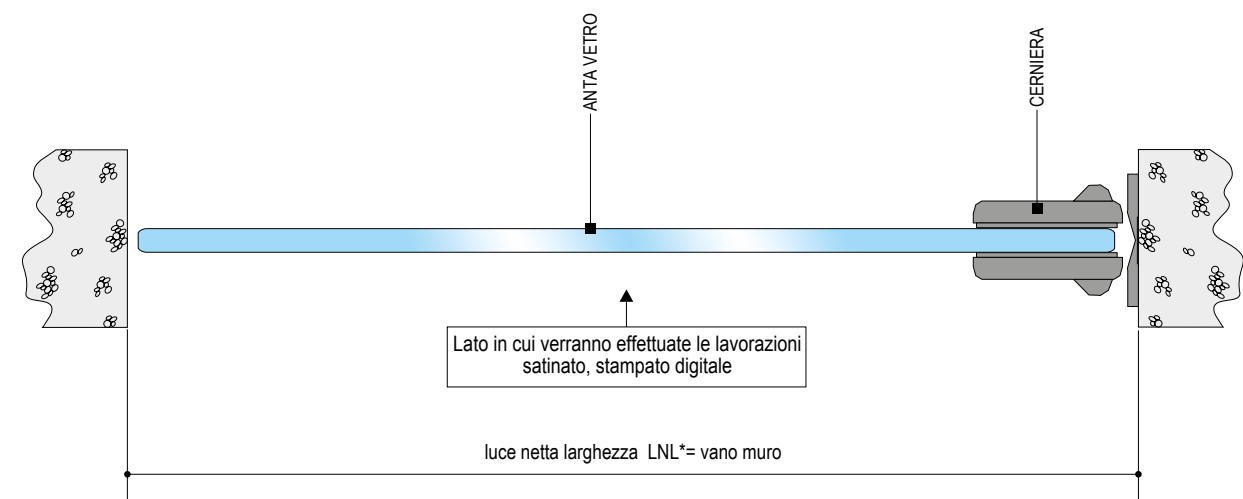

Tutti i riferimenti con l'asterisco (*) sono da indicare nell'ordine

MANO D'APERTURA

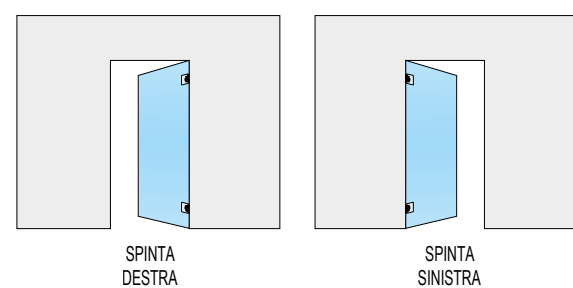

GLD MATIQUE 66

APERTURA CON CERNIERE AUTOMATICHE DUE ANTE
 DOUBLE-LEAF OPENING WITH AUTOMATIC HINGES

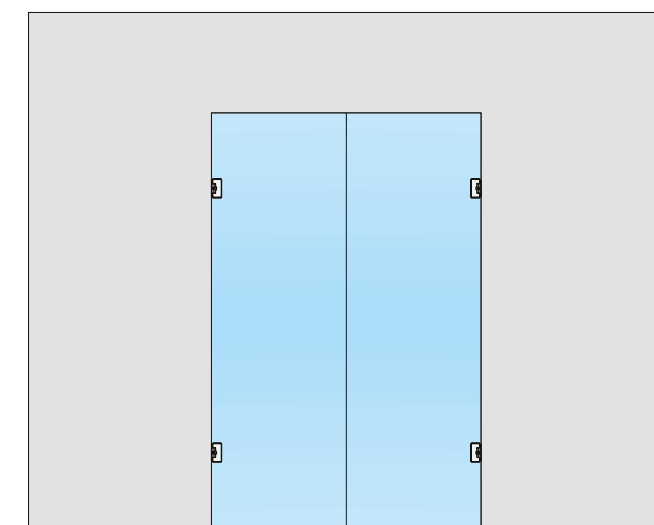
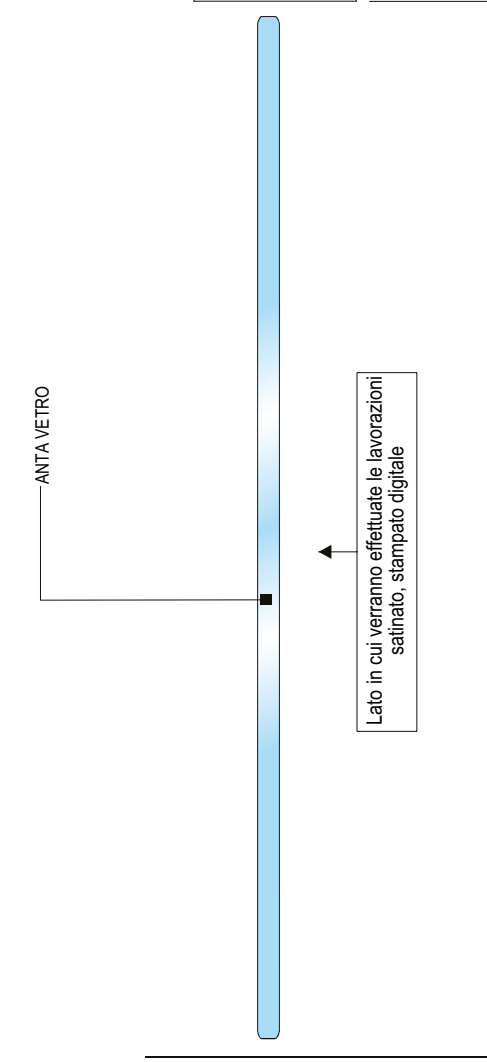
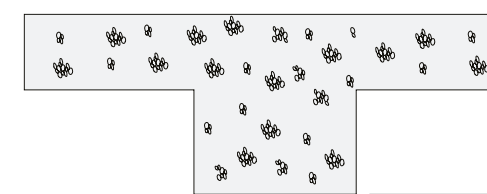
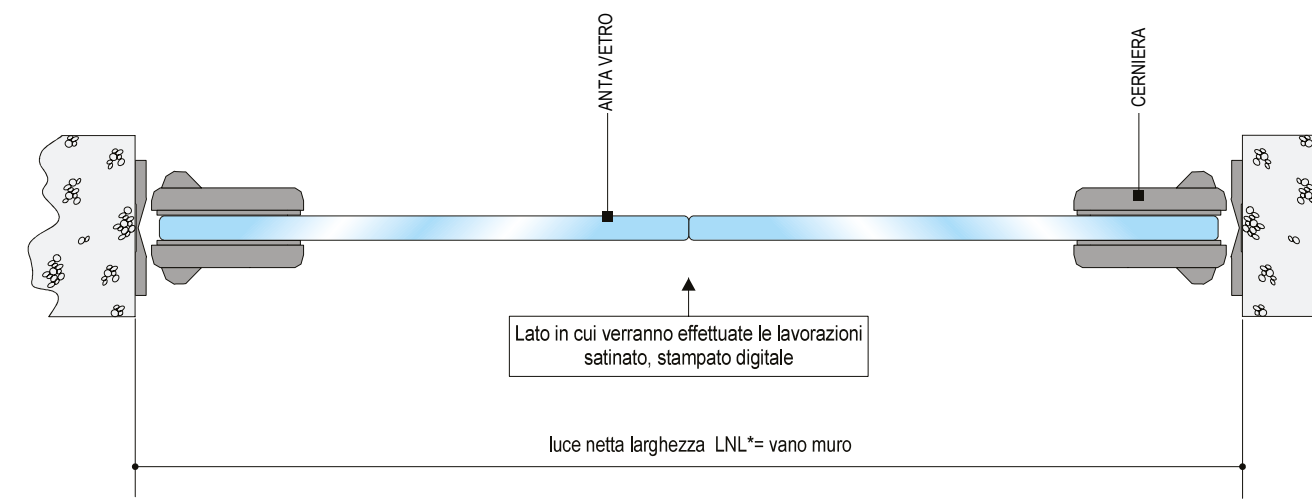

Tutti i riferimenti con l'asterisco (*) sono da indicare nell'ordine

MANO D'APERTURA

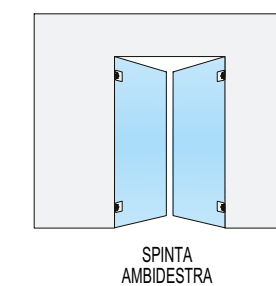

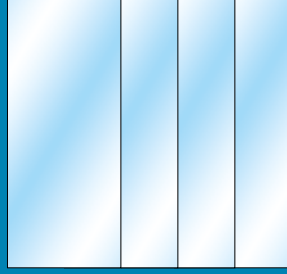

GLD 482

PER PORTA DUE/TRE ANTE TRASCINATE + ANTA FISSA
 FOR TWO/THREE SLIDED DOORS + FIXED LEAF

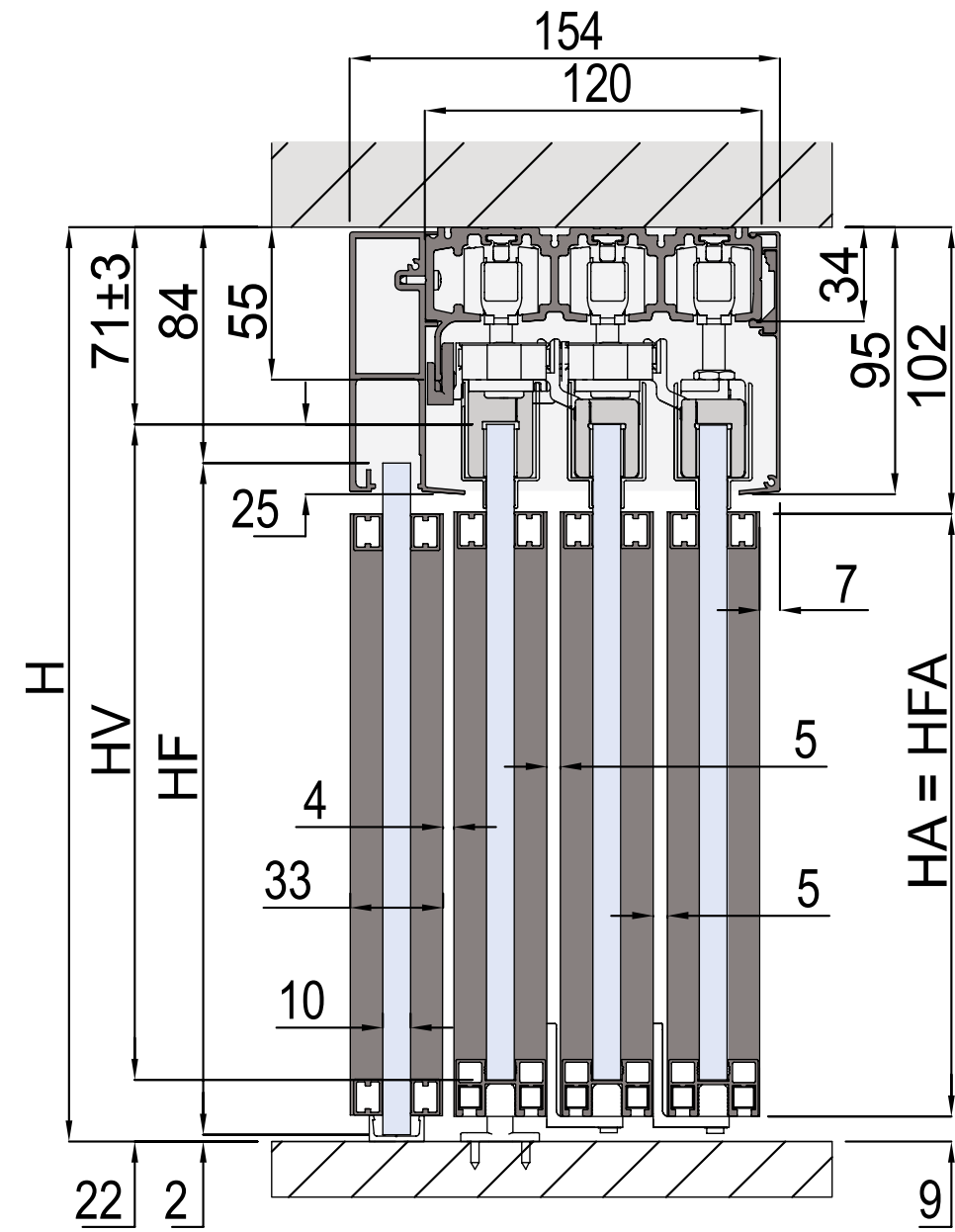

$HV = H - 93$
 $HF = H - 86$
 $HA/HFA = H - 111$

(solo ante simmetriche)
 (symmetrical leaves only)

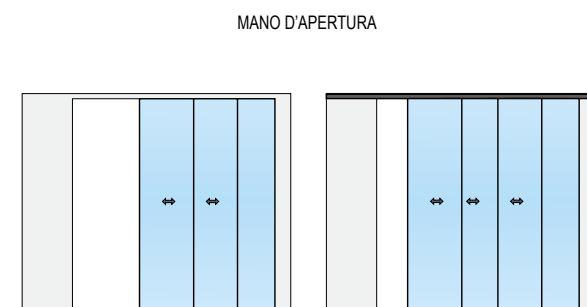

www.dierre.com

DIERRE SPA STRADA STATALE PER CHERI 66/15 - 14019 VILLANOVA D'ASTI (AT)

TEL. +39 0141 949411 - E-MAIL: info@dierre.it

La carta scelta per questo prodotto è Carta Certificata FSC® per una gestione responsabile delle foreste e degli ecosistemi.

The paper chosen for this product is FSC® Certified Paper for responsible management of forests and ecosystems.



L'ambientazione ed il contesto estetico in cui le immagini delle porte sono state inserite sono puramente suggestivi e, pertanto, alcuni elementi presenti nelle foto (quali a titolo esemplificativo cornici, coprifili, accessori) potrebbero non essere disponibili o dover essere oggetto di specifica richiesta in sede di ordine.

The setting and aesthetic context the images of the doors have been inserted in are merely inspiring and, therefore, some items in the pictures (such as for example cornices, cover moulds, accessories) may not be available or be the subject of a specific request when ordering.

Le informazioni presenti in questo catalogo possono subire variazioni.

I materiali rappresentati sono puramente indicativi: per la verifica dei colori si rimanda al campionario.

The information contained in this catalogue may undergo variations.

The materials shown are a bare example: for the verification of colours please refer to the sample collection.

LUCENTI